

# CATALOGUE

furniture  
2 0 2 4





### WINNER BEST CUSTOM STAND



### YOUNG ACHIEVER AWARD



## ABOUT EXHIBIT SYSTEMS

Exhibit Systems has serviced the exhibition and events industry throughout Australia since its formation in March 2000. The Company has grown into one of Australia's most trusted exhibition and event providers servicing hundreds of exhibitions and events annually. Products & Services include modular exhibition booths, custom stand design and production, electrics, furniture and audio-visual, design and project management, right through to logistical support. With branches in: Sydney (Head Office), Melbourne and Brisbane, Exhibit Systems can offer creative solutions for any event.

For more information, please contact one of our Account Managers today.

### SYDNEY



+61 2 9982 5511



PO Box 801, Freshwater NSW 2096



5 Boola Place, Cromer NSW 2099



sales@exhibitsystems.com.au



www.exhibitsystems.com.au

### BRISBANE / GOLD COAST



+61 7 3805 1543



25 High Road, Bethania QLD 4205

### MELBOURNE



+61 3 8375 1638



37 Sunline Drive, Truganina VIC 3029

### FOLLOW US ON



**exhibit**<sup>®</sup>  
systems ●●●●

|  |    |
|--|----|
| Carpeting & Raised Floors & Furniture Packages | 4  |
| Furniture - Settings                           | 6  |
| Furniture - Lounges                            | 9  |
| Furniture - Stools & Chairs                    | 11 |
| Furniture - Ottomans & Benches                 | 14 |
| Furniture - Tables                             | 15 |
| Furniture - Counters                           | 18 |
| Counter & Table Graphics                       | 20 |
| Furniture - Brochure Holders                   | 21 |
| Furniture - Display Pods, Slatwall & Pegboard  | 22 |
| Furniture - Display Panels & Plinths           | 23 |
| Furniture - Business Accessories               | 24 |
| Furniture - Outdoor Accessories & Barriers     | 25 |
| Furniture - Hospitality                        | 26 |
| Furniture - Fashion Displays                   | 27 |
| Furniture - Glass Displays                     | 28 |
| Audio / Visual                                 | 32 |
| Sign Frames                                    | 34 |
| Faux Pot Plants & Foliage                      | 35 |
| Terms & Conditions                             | 36 |



# CARPETING & RAISED FLOORS

Exhibit Systems offers a range of flooring solutions - from entire exhibition halls of carpet tiles, to stepped and ramped raised floors for custom stands and feature areas.

We offer 32mm ramped and 115mm stepped raised floors with a wide range of carpet or timber laminate finishes.

## CARPET TILES

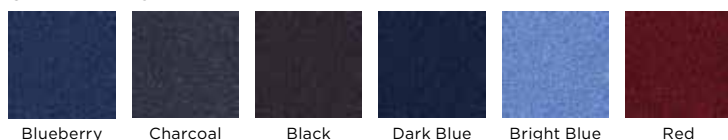

## RAISED FLOOR

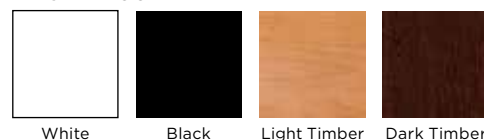

## NEEDLE PUNCH CARPET ROLLS

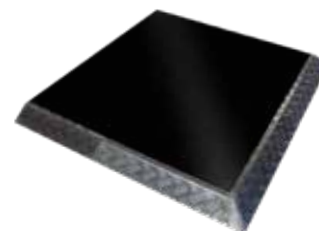
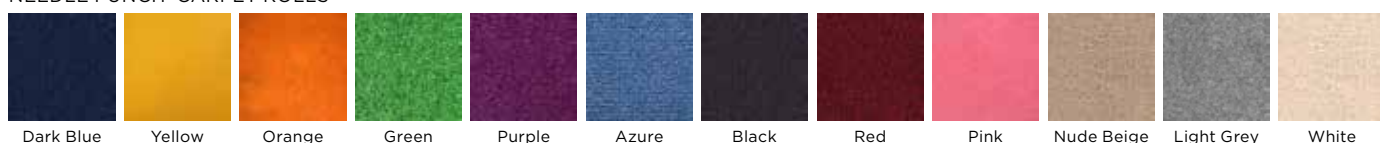

### FLOORING

#### Carpet Tiles

- 1 x 1m carpet tiles

#### Available Colours

|  |             |               |      |
|--|-------------|---------------|------|
|  | Black       | <b>072002</b> | \$27 |
|  | Red         | <b>072003</b> | \$27 |
|  | Dark Blue   | <b>072005</b> | \$22 |
|  | Bright Blue | <b>072006</b> | \$22 |
|  | Pink        | <b>072008</b> | \$33 |
|  | Charcoal    | <b>072009</b> | \$22 |
|  | Blueberry   | <b>072010</b> | \$22 |
|  | Teal        | <b>072012</b> | \$22 |

### FLOORING

#### Needle Punch Carpet Rolls

- Prices are per square metres & subject to availability.

#### Available Colours

|  |            |      |
|--|------------|------|
|  | Black      | \$55 |
|  | Red        | \$55 |
|  | Dark Blue  | \$55 |
|  | Azure      | \$55 |
|  | Yellow     | \$55 |
|  | Green      | \$55 |
|  | Light Grey | \$55 |
|  | Purple     | \$55 |
|  | Orange     | \$55 |

### FLOORING

#### 32mm Raised

- 1 x 1m laminate timber tiles
- 32mm height
- Includes aluminium treadplate
- Ramped edge

#### Available Colours

|  |            |               |       |
|--|------------|---------------|-------|
|  | White      | <b>071901</b> | \$90  |
|  | Black      | <b>071902</b> | \$98  |
|  | Light      | <b>071904</b> | \$103 |
|  | Dark       | <b>071915</b> | \$125 |
|  | Treadplate | <b>071917</b> | \$135 |

# FURNITURE PACKAGES

## PACKAGE 1

Walk On Furniture  
FP1001

**SAVE \$44** **\$396**



• Bella Bar Table x 1



• Tori Stool x 2



• Folding Brochure Rack x 1

## PACKAGE 2

Walk On Furniture  
FP1002

**SAVE \$70** **\$628**

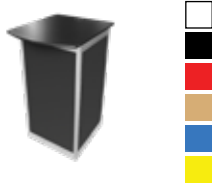

• Octa Computer Module x 1



• Tori Setting x 1



• Folding Brochure Rack x 1

## PACKAGE 3

Walk On Furniture  
FP1003

**SAVE \$77** **\$697**



• Octa Lockable Counter x 1



• Origami Stool Setting x 1



• Folding Brochure Rack x 1

## PACKAGE 4

Walk On Furniture  
FP1004

**SAVE \$80** **\$717**



• Maxima Lockable Counter x 1



• Canton Chair Setting x 1



• Folding Brochure Rack x 1

## PACKAGE 5

Walk On Furniture  
FP1005

**SAVE \$96** **\$868**



• Octa Curved Counter x 1



• Pop Stools x 2



• Linda Setting x 1



• Folding Brochure Rack x 1

## PACKAGE 6

Walk On Furniture  
FP1006

**SAVE \$160** **\$1442**



• Octa Lockable Counter x 1



• Origami Setting x1



• 43" Plasma On Stand



• Folding Brochure Rack x 1

## PACKAGE 7

Walk On Furniture  
FP1007

**SAVE \$198** **\$1782**



• Octa Lockable Counter x 1



• Siena Stool Setting x1



• 43" Plasma On Stand



• Folding Brochure Rack x 1

# FURNITURE | STOOL SETTINGS



**SAVE \$41**

## ORIGAMI STOOL SETTING \$365

*Setting*

- 1 x White Bella Bar table (1045mm height)
- 3 x Origami Stools – see colour options below

*Available Colours*

- 091401
- 091402
- 091403
- 091405
- 091409



**SAVE \$45**

## POP STOOL SETTING \$403

*Setting*

- 1 x White Bella Bar Table (1045mm height)
- 3 x Pop Stools – see colour options below

*Available Colours*

- 091802
- 091803
- 091809
- 091811
- 091815



**SAVE \$83**

## SIENA STOOL SETTING \$743

*Setting*

- 1 x White Siena Table (1057mm height)
- 4 x Wave Stools

*Available Colours*

- 091601



**SAVE \$61**

## TOLIX STOOL SETTING \$552

*Setting*

- 1 x Long Tolix Bar Table – Timber option (1070mm height)
- 4 x Tolix Stools – see colour options below

*Available Colours*

- 091101
- 091102
- 091103
- 091105
- 091108
- 091111
- 091301
- 091107



**SAVE \$42**

## TORI STOOL SETTING \$376

*Setting*

- 1 x White Bella Bar table (1045mm height)
- 3 x Tori Stools – see colour options below

*Available Colours*

- 091502
- 091503
- 091505
- 091508
- 091509



**SAVE \$41**

## VOGUE STOOL SETTING \$365

*Setting*

- 1 x White Bella Bar Table (1045mm height)
- 3 x Vogue stools – see colour options below

*Available Colours*

- 090701
- 090702
- 090703
- 090705

# FURNITURE | CHAIRS & BENCH SETTINGS



**SAVE \$36**

## CANTON CHAIR SETTING

**\$326**

*Setting*

- 1 x White Bella table (760mm height)
- 4 x Canton chairs - see colour options below

*Available Colours*

090101  
  090102  
  090103  
  090105



**SAVE \$36**

## ORIGAMI CHAIR SETTING

**\$326**

*Setting*

- 1 x White Bella table (760mm height)
- 4 x Origami Chairs - see colour options below

*Available Colours*

091411  
  091412  
  091413  
  091415  
 091419



**SAVE \$41**

## TOLIX CHAIR SETTING

**\$371**

*Setting*

- 1 x Tolix table - Timber option (760mm height)
- 4 x Tolix chairs - see colour options below

*Available Colours*

091001  
  091002  
  091008  
  091003  
 091005  
 091011



**SAVE \$37**

## TORI CHAIR SETTING

**\$337**

*Setting*

- 1 x White Bella table (760mm height)
- 4 x Tori Chairs - see colour options below

*Available Colours*

091512  
  091513  
  091515  
  091518  
 091519



# FURNITURE | OTTOMAN & LOUNGE SETTINGS



**SAVE \$41**

## BRUNO BENCH SETTING \$373

*Setting*

- 1 x White TT Coffee Table (900mm x 450mm)
- 2 x Bruno Benches - see colour options below

*Available Colours*

- 100111     100112     100113     100115  
 100119



**SAVE \$49**

## GEORGE OTTOMAN SETTING \$445

*Setting*

- 1 x White TT Coffee table (900mm x 450mm)
- 4 x George Ottomans - see colour options below

*Available Colours*

- 100101     100102     100103     100105



**SAVE \$39**

## LINDA LOUNGE SETTING \$352

*Setting*

- 1 x White Bella Coffee table (440mm height)
- 2 x Linda Chairs - see colour options below

*Available Colours*

- 100725     100728     100727     100729



**SAVE \$81**

## MILAN DOUBLE SETTING \$727

*Setting*

- 1 x TT Coffee Table (900mm x 450mm)
- 2 x Double Milan Lounges - see colour options below

*Available Colours*

- 100601     100602



**SAVE \$55**

## MILAN SINGLE SETTING \$499

*Setting*

- 1 x TT Square Coffee Table (750 x 750mm)
- 2 x Single Milan Lounges - see colour options below

*Available Colours*

- 100501     100502



**SAVE \$73**

## ROMA LOUNGE SETTING \$654

*Setting*

- 1 x Black Bella Coffee table (440mm height)
- 2 x Roma Chairs

*Available Colours*

- 100302



# FURNITURE | LOUNGE SETS



**FELO DOUBLE** \$347

Lounge

- Soft cotton upholstery & wooden frame
- A single seater version is available for hire

Available Colours

■ 032120



**MILAN DOUBLE** \$347

Lounge

- Leather upholstery & chrome frame
- 1560(w) x 800(d) x 800mm(h)

Available Colours

□ 030501 ■ 030502



**SOTTI DOUBLE** \$287

Lounge

- Sleek cotton upholstery & chrome frame
- A single seater version is available for hire

Available Colours

■ 031039



**FELO** \$260

Lounge Chair

- Cotton upholstery & wooden frame
- A two-seater version is available

Available Colours

■ 032020



**MILAN SINGLE** \$220

Lounge Chair

- Leather upholstery & chrome frame
- 800(w) x 730(d) x 700mm(h)

Available Colours

□ 030401 ■ 030402



**SOTTI SINGLE** \$184

Lounge Chair

- Cotton upholstery & chrome frame

Available Colours

■ 030709



**CURVE ENDLESS**

Lounge

- High quality vinyl make & chrome frame
- Price is for each individual lounge piece
- 1430(w) x 1220(d) x 690mm(h)

Available Colours

White □ 031801 \$260  
 Grey ■ 031809 \$260



# FURNITURE | LOUNGES



**AVA** \$141

Lounge Chair

- Cushioned chair with soft, velvet texture

Available Colours

■ 030815



**BARCELONA** \$206

Lounge Chair

- Leather upholstery & chrome base
- 750(w) x 800(d) x 700mm(h)

Available Colours

■ 030802 □ 030801



**CAPRI TUB** \$137

Lounge Chair

- Leather upholstery
- 750(w) x 670(d) x 750mm(h)

Available Colours

■ 031002 ■ 031015



**VIDA** \$137

Lounge Chair

- Cushioned chair with soft, velvet texture

Available Colours

■ 032222 ■ 032223



**LINDA** \$141

Lounge Chair

- Cushioned chair with soft, velvet texture

Available Colours

■ 030735 ■ 030737 ■ 030738 ■ 030739

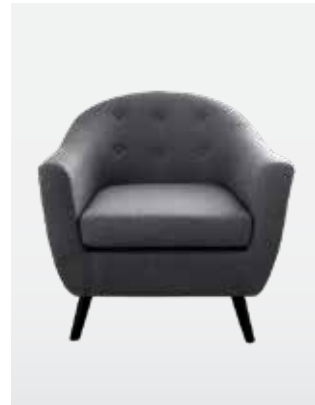

**LUXO** \$220

Lounge Chair

- Cotton upholstery & matte frame

Available Colours

■ 031905



**MELBI** \$260

Lounge Chair

- Material upholstery

Available Colours

■ 031520



**NOVA** \$125

Lounge Chair

- Cotton upholstery & chrome frame

Available Colours

■ 031022 ■ 031023  
■ 031025 ■ 031029



**ROMA** \$309

Lounge Chair

- Velour upholstery
- Chrome Base

Available Colours

■ 030702



**SCAV** \$137

Lounge Chair

- Cotton upholstery & wooden frame

Available Colours

■ 012020



**VERA** \$200

Lounge Chair

- Cotton upholstery & chrome frame

Available Colours

■ 031042 ■ 031043  
■ 031045 ■ 031049

# FURNITURE | STOOLS & CHAIRS



**BENJI** \$101

Stool

- Modern look stool with sculpted timber seating

Available Colours

020404



**BROOKLYN** \$114

Stool

- Upholstered cushion seat with back rest and adjustable chrome base

Available Colours

021202

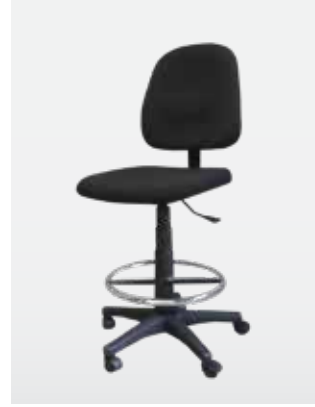

**DRAFTING** \$95

Stool

- Upholstered seat with backrest
- Adjustable height (600 - 700mm)

Available Colours

020702



**FLORIDA** \$88

Stool

- Upholstered cushioned seat & chrome base

Available Colours

020102



**GHOST** \$109

Stool

- Clear plastic stool

Available Colours

021318



**MIURA** \$104

Stool

- Modern plastic stool

Available Colours

021101  021102



**ORIGAMI** \$95

Stool

- Sleek plastic stool
- Sturdy chrome frame

Available Colours

020141  020142  
 020143  020144  
 020145



**OVELA** \$114

Stool

- Leather upholstery
- Adjustable chrome base

Available Colours

021810



**POP** \$109

Stool

- Leather upholstery
- Sturdy chrome frame

Available Colours

021122  021123  
 021124  021126  
 021128



**46CM TOLIX** \$91

Stool

- Solid steel legs with metal seat

Available Colours

021501  021502  
 021503  021505  
 021508  021511



**66CM TOLIX** \$101

Stool

- Powder coated steel legs with wooden seat

Available Colours

021601  021602



**66CM TOLIX** \$91

Stool

- Solid steel legs with metal seat

Available Colours

021401  021402  
 021403  021405  
 021407  021408  
 021411  021416

# FURNITURE | STOOLS & CHAIRS



**TORI** \$99

Stool

- Cotton upholstery & chrome frame

Available Colours

- 020621    ■ 020622
- 020623    ■ 020625
- 020628



**TRIESTE** \$114

Stool

- Cotton upholstery & chrome frame

Available Colours

- 021709

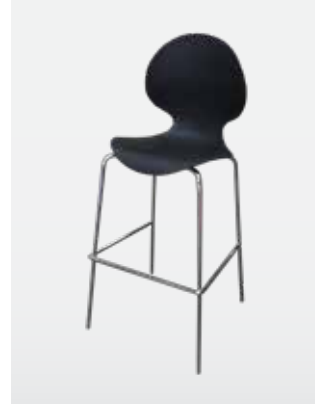

**VOGUE** \$95

Stool

- Plastic seat with backrest & chrome legs

Available Colours

- 020601    ■ 020602
- 020603    ■ 020605



**WAVE** \$124

Stool

- Wooden stool with sleek design

Available Colours

- 020406



**BETIS** \$62

Chair

- Plastic seat & aluminium legs/arms

Available Colours

- 010202    ■ 010209



**CANTON** \$62

Chair

- Plastic seat & chrome legs

Available Colours

- 010101    ■ 010102
- 010103    ■ 010105



**EAMES** \$109

Chair

- Upholstered seat & gas lift with castors

Available Colours

- 011301    ■ 011302



**EIFFEL** \$62

Chair

- Stainless steel base & molded plastic seat

Available Colours

- 011801



**FINELINE** \$61

Chair

- Upholstered seat & chrome legs

Available Colours

■ 010420

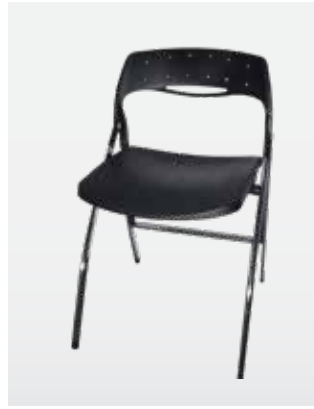

**FOLDING** \$47

Chair

- Plastic seat & chrome legs

Available Colours

■ 010601 ■ 010602



**FRESCO** \$61

Chair

- Molded Plastic seat

Available Colours

□ 011901 ■ 011905

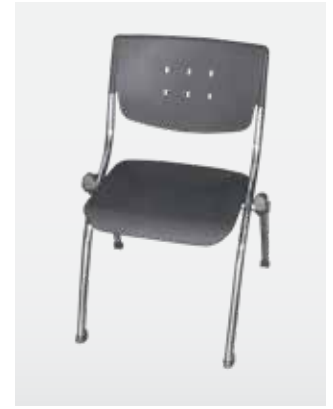

**HARVARD** \$57

Chair

- Plastic seat & interlocking chrome legs

Available Colours

■ 010309



**ORIGAMI** \$62

Chair

- Plastic seat & chrome frame

Available Colours

□ 010141 ■ 010142  
■ 010143 ■ 010144  
■ 010145

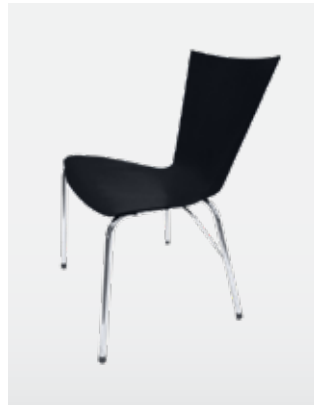

**STORM** \$62

Chair

- Plastic seat & chrome legs

Available Colours

■ 011502 ■ 011503  
■ 011505 ■ 011507



**TOLIX** \$61

Chair

- Powder coated steel

Available Colours

□ 011601 ■ 011602  
■ 011603 ■ 011608  
■ 011605 ■ 011611



**TORI** \$65

Chair

- Cotton upholstery & chrome frame

Available Colours

■ 010121 ■ 010122  
■ 010123 ■ 010125  
■ 010128



**TYPIST** \$62

Chair

- Cushioned seat, adjustable height & castors

Available Colours

■ 010702



**VIENTO** \$65

Chair

- Molded plastic

Available Colours

□ 011701



# FURNITURE | OTTOMANS & BENCHES



## NELSON

Bench

- Strong wooden frame in a stylish black shade
- Comes in two lengths; 1220mm & 1520mm

|        |               |              |
|--------|---------------|--------------|
| 1220mm | <b>032230</b> | <b>\$163</b> |
| 1520mm | <b>032231</b> | <b>\$190</b> |



## BRUNO

Bench

- High quality woven cotton upholstery with a strong chrome base
- 1200mm(w) x 400mm(d) x 450mm(h)

**\$150**

Available Colours

|                                 |  |  |  |  |
|---------------------------------|--|--|--|--|
| <input type="checkbox"/> 032241 | <input checked="" type="checkbox"/> 032242 | <input checked="" type="checkbox"/> 032243 | <input checked="" type="checkbox"/> 032245 | <input checked="" type="checkbox"/> 032249 |
|---------------------------------|--|--|--|--|



## GEORGE

Ottoman

- Vinyl upholstery with a cushioned seat
- 450(w) x 450(d) x 450mm(h)

**\$95**

Available Colours

|                                 |  |  |  |  |
|---------------------------------|--|--|--|--|
| <input type="checkbox"/> 030101 | <input checked="" type="checkbox"/> 030102 | <input checked="" type="checkbox"/> 030103 | <input checked="" type="checkbox"/> 030105 | <input checked="" type="checkbox"/> 030111 |
|---------------------------------|--|--|--|--|



## MADRID

Ottoman

- Vinyl upholstery with a cushioned seat
- 450(w) x 450mm(h)

**\$95**

Available Colours

|                                 |  |  |  |
|---------------------------------|--|--|--|
| <input type="checkbox"/> 030301 | <input checked="" type="checkbox"/> 030302 | <input checked="" type="checkbox"/> 030303 | <input checked="" type="checkbox"/> 030311 |
|---------------------------------|--|--|--|



## BEAN BAGS

**\$65**

Seating

- Black bean bags are Corduroy
- Green are made of vinyl

Available Colours

|  |  |
|--|--|
| <input checked="" type="checkbox"/> 031302 | <input checked="" type="checkbox"/> 031303 |
| <input checked="" type="checkbox"/> 031307 | <input checked="" type="checkbox"/> 031308 |
| <input type="checkbox"/> 031301            | <input checked="" type="checkbox"/> 031305 |



## CUSHIONS

**\$29**

Accessories

- Square cushions (400 x 400mm)

Available Colours

|  |  |
|--|--|
| <input type="checkbox"/> 069001            | <input checked="" type="checkbox"/> 069002 |
| <input checked="" type="checkbox"/> 069003 | <input checked="" type="checkbox"/> 069005 |
| <input checked="" type="checkbox"/> 069008 | <input checked="" type="checkbox"/> 069011 |

# FURNITURE | COFFEE TABLES



**BELLA COFFEE** \$109

Table

- Digital Print (075201) + \$104
- 750(w) x 440mm(h)

Available Colours

- |                                 |                                 |                                 |
|---------------------------------|---------------------------------|---------------------------------|
| <input type="checkbox"/> 040301 | <input type="checkbox"/> 040302 | <input type="checkbox"/> 040303 |
| <input type="checkbox"/> 040304 | <input type="checkbox"/> 040305 | <input type="checkbox"/> 040307 |
| <input type="checkbox"/> 040311 | <input type="checkbox"/> 040308 |                                 |



**CROSBY** \$60

Table

- Interwoven metal lengths create a sleek modern look

Available Colours

- |                                 |                                 |
|---------------------------------|---------------------------------|
| <input type="checkbox"/> 042221 | <input type="checkbox"/> 042224 |
|---------------------------------|---------------------------------|



**HAVANA COFFEE** \$118

Table

- 500(w) x 450mm(h)

Available Colours

- |                                 |
|---------------------------------|
| <input type="checkbox"/> 042802 |
|---------------------------------|



**MILA COFFEE** \$126

Table

- 400(w) x 475mm(h)

Available Colours

- |                                 |
|---------------------------------|
| <input type="checkbox"/> 042204 |
|---------------------------------|



**TT COFFEE** \$114

Table

- Digital Print (075301) + \$75
- 900(w) x 450(d) x 430mm(h)

Available Colours

- |                                 |                                 |                                 |
|---------------------------------|---------------------------------|---------------------------------|
| <input type="checkbox"/> 040601 | <input type="checkbox"/> 040602 | <input type="checkbox"/> 040603 |
| <input type="checkbox"/> 040604 | <input type="checkbox"/> 040605 | <input type="checkbox"/> 040615 |



**TT SQUARE COFFEE** \$114

Table

- Digital Print (075401) + \$104
- 750(w) x 750(d) x 430mm(h)

Available Colours

- |                                 |                                 |                                 |
|---------------------------------|---------------------------------|---------------------------------|
| <input type="checkbox"/> 040701 | <input type="checkbox"/> 040702 | <input type="checkbox"/> 040703 |
| <input type="checkbox"/> 040704 | <input type="checkbox"/> 040705 | <input type="checkbox"/> 040715 |



# FURNITURE | TABLES



**BELLA** \$114

Table

- Digital Print (075001) + \$104
- 750(w) x 760mm(h)

Available Colours

- |                                 |                                 |                                 |
|---------------------------------|---------------------------------|---------------------------------|
| <input type="checkbox"/> 040101 | <input type="checkbox"/> 040102 | <input type="checkbox"/> 040103 |
| <input type="checkbox"/> 040104 | <input type="checkbox"/> 040105 | <input type="checkbox"/> 040107 |
| <input type="checkbox"/> 040108 | <input type="checkbox"/> 040111 |                                 |

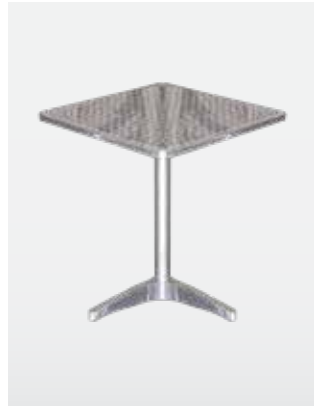

**SQUARE CAFE** \$95

Table

- 600(w) x 600(d) x 760mm(h)

Available Colours

- |                                 |
|---------------------------------|
| <input type="checkbox"/> 040414 |
|---------------------------------|



**TOLIX** \$168

Table

- White legs & interchangeable table top
- 700(w) x 700(d) x 750mm(h)

Available Colours

- |                                 |                                 |                                 |
|---------------------------------|---------------------------------|---------------------------------|
| <input type="checkbox"/> 041901 | <input type="checkbox"/> 041902 | <input type="checkbox"/> 041903 |
| <input type="checkbox"/> 041904 | <input type="checkbox"/> 041905 | <input type="checkbox"/> 041908 |
| <input type="checkbox"/> 041911 |                                 |                                 |



**LONG TOLIX** \$233

Table

- White legs & interchangeable table top
- 795(w) x 1400(d) x 750mm(h)

Available Colours

- |                                 |                                 |                                 |
|---------------------------------|---------------------------------|---------------------------------|
| <input type="checkbox"/> 042601 | <input type="checkbox"/> 042602 | <input type="checkbox"/> 042604 |
|---------------------------------|---------------------------------|---------------------------------|



## ELITE TABLES

Table

**Elite Meeting** 2100(w) x 900(d) x 750mm(h) \$155

- |                                 |                                 |                                 |                                 |
|---------------------------------|---------------------------------|---------------------------------|---------------------------------|
| <input type="checkbox"/> 040901 | <input type="checkbox"/> 040902 | <input type="checkbox"/> 040904 | <input type="checkbox"/> 040915 |
|---------------------------------|---------------------------------|---------------------------------|---------------------------------|

**Elite 1500** 1500(w) x 750(d) x 750mm(h) \$125

- |                                 |                                 |                                 |                                 |                                 |                                 |
|---------------------------------|---------------------------------|---------------------------------|---------------------------------|---------------------------------|---------------------------------|
| <input type="checkbox"/> 041001 | <input type="checkbox"/> 041002 | <input type="checkbox"/> 041003 | <input type="checkbox"/> 041004 | <input type="checkbox"/> 041005 | <input type="checkbox"/> 041015 |
|---------------------------------|---------------------------------|---------------------------------|---------------------------------|---------------------------------|---------------------------------|

**Elite Square** 750(w) x 750(d) x 750mm(h) \$101

- |                                 |                                 |                                 |                                 |                                 |                                 |
|---------------------------------|---------------------------------|---------------------------------|---------------------------------|---------------------------------|---------------------------------|
| <input type="checkbox"/> 040801 | <input type="checkbox"/> 040802 | <input type="checkbox"/> 040803 | <input type="checkbox"/> 040804 | <input type="checkbox"/> 040805 | <input type="checkbox"/> 040815 |
|---------------------------------|---------------------------------|---------------------------------|---------------------------------|---------------------------------|---------------------------------|



**COVERED TRESTLE** \$114

Table

- 1830(w) x 760(d) x 760mm(h)

Available Colours

- |                                 |                                 |
|---------------------------------|---------------------------------|
| <input type="checkbox"/> 041101 | <input type="checkbox"/> 041102 |
|---------------------------------|---------------------------------|



**PLASTIC TRESTLE**

Table

- 1830(w) x 760(d) x 760mm(h)

041209 \$77

- 1500(w) x 760(d) x 760mm(h)

041109 \$60



**TABLE CLOTHS** \$39

Accessories

- Two sizes available
- Short, 2200(w) x 1800mm(d)
- Long, 2400(w) x 1800mm(d)

Available Colours

- |                                 |                                 |                                 |                                 |
|---------------------------------|---------------------------------|---------------------------------|---------------------------------|
| <input type="checkbox"/> 061301 | <input type="checkbox"/> 061302 | <input type="checkbox"/> 061303 | <input type="checkbox"/> 061315 |
| <input type="checkbox"/> 061308 | <input type="checkbox"/> 061307 |                                 |                                 |



# FURNITURE | BAR TABLES



**AMALFI BAR** \$230

Table

- Chrome legs & wooden table top
- 1600(w) x 550(d) x 1100mm(h)

Available Colours

- 041701
- 041702
- 041704



**AZZURRI BAR** \$238

Table

- 1880(w) x 675(d) x 1100mm(h)

Available Colours

- 041801
- 041802
- 041803
- 041804
- 041805



**BELLA BAR** \$121

Table

- Digital Print (075101) + \$104
- 750(w) x 1045mm(h)

Available Colours

- 040201
- 040202
- 040203
- 040204
- 040205
- 040207
- 040208
- 040211



**TOLIX BAR** \$173

Table

- White legs & interchangeable table top
- 700(w) x 700(d) x 1070mm(h)

Available Colours

- 042001
- 042002
- 042004
- 042005
- 042003
- 042008
- 042011



**LONG TOLIX BAR** \$249

Table

- 1500(w) x 600(d) x 1070mm(h)

Available Colours

- 042301
- 042302
- 042304

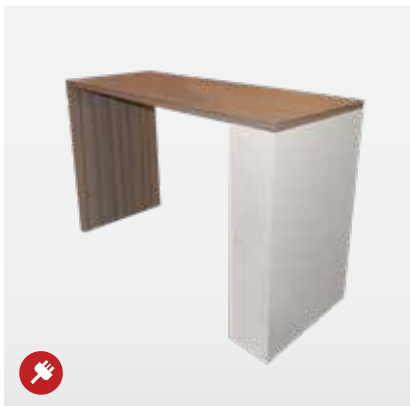

**EGGER BAR** \$453

Table

- 1500(w) x 500(d) x 1000mm(h)
- Powerpoint connectivity built into tabletop

Available Colours

- 042415



**GENIUS BAR** \$494

Table

- 2000(w) x 700(d) x 1000mm(h)
- Powerpoint connectivity built into tabletop

Available Colours

- 042021



**SIENA BAR** \$330

Table

- 1406(w) x 600(d) x 1057mm(h)
- Printed panel for sides available

Available Colours

- 041601

# FURNITURE | COUNTERS

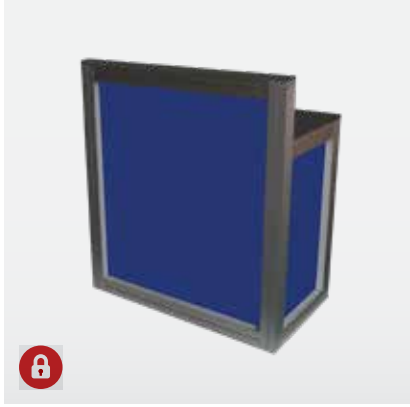

**MAXIMA COUNTER** \$350  
Counter

- 1110(w) x 615(d) x 1200/900mm(h)
- Lockable door

Available Colours

- |                                 |                                 |                                 |
|---------------------------------|---------------------------------|---------------------------------|
| <input type="checkbox"/> 051001 | <input type="checkbox"/> 051002 | <input type="checkbox"/> 051003 |
| <input type="checkbox"/> 051004 | <input type="checkbox"/> 051005 | <input type="checkbox"/> 051007 |



**MAXIMA DESK EXT** \$407  
Counter

- 1850(w) x 615(d) x 1200/900mm(h)
- Lockable door

Available Colours

- |                                 |                                 |                                 |
|---------------------------------|---------------------------------|---------------------------------|
| <input type="checkbox"/> 051101 | <input type="checkbox"/> 051102 | <input type="checkbox"/> 051103 |
| <input type="checkbox"/> 051104 | <input type="checkbox"/> 051105 | <input type="checkbox"/> 051107 |



**MAXIMA LOCKABLE** \$350  
Counter

- 1110(w) x 615(d) x 1000mm(h)
- Lockable door

Available Colours

- |                                 |                                 |                                 |
|---------------------------------|---------------------------------|---------------------------------|
| <input type="checkbox"/> 051601 | <input type="checkbox"/> 051602 | <input type="checkbox"/> 051603 |
| <input type="checkbox"/> 051604 | <input type="checkbox"/> 051605 | <input type="checkbox"/> 051607 |



**OCTA CORNER** \$315  
Counter

- Lockable doors

Available Colours

- |                                 |                                 |                                 |
|---------------------------------|---------------------------------|---------------------------------|
| <input type="checkbox"/> 051301 | <input type="checkbox"/> 051302 | <input type="checkbox"/> 051303 |
| <input type="checkbox"/> 051304 | <input type="checkbox"/> 051305 | <input type="checkbox"/> 051307 |



**OCTA CURVED** \$273  
Counter

- 1440(w) x 730(d) x 1000mm(h)
- Open at back

Available Colours

- |                                 |                                 |                                 |
|---------------------------------|---------------------------------|---------------------------------|
| <input type="checkbox"/> 050801 | <input type="checkbox"/> 050802 | <input type="checkbox"/> 050803 |
| <input type="checkbox"/> 050804 | <input type="checkbox"/> 050805 | <input type="checkbox"/> 050807 |

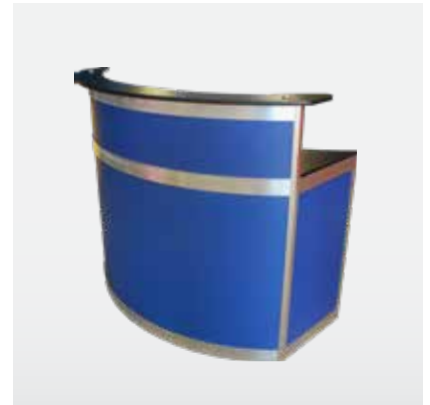

**OCTA CURVED RECEPTION** \$345  
Counter

- 1440(w) x 730(d) x 1200/900mm(h)

Available Colours

- |                                 |                                 |                                 |
|---------------------------------|---------------------------------|---------------------------------|
| <input type="checkbox"/> 050701 | <input type="checkbox"/> 050702 | <input type="checkbox"/> 050703 |
| <input type="checkbox"/> 050704 | <input type="checkbox"/> 050705 | <input type="checkbox"/> 050707 |



**OCTA CURVED REVERSED** \$273  
Counter

- 1440(w) x 730(d) x 1000mm(h)
- Open at back

Available Colours

- |                                 |                                 |                                 |
|---------------------------------|---------------------------------|---------------------------------|
| <input type="checkbox"/> 050901 | <input type="checkbox"/> 050902 | <input type="checkbox"/> 050903 |
| <input type="checkbox"/> 050904 | <input type="checkbox"/> 050905 | <input type="checkbox"/> 050907 |



**OCTA DESK** \$185  
Desk

- 1565(w) x 780(d) x 785mm(h)
- Open at back

Available Colours

- |                                 |                                 |                                 |
|---------------------------------|---------------------------------|---------------------------------|
| <input type="checkbox"/> 050601 | <input type="checkbox"/> 050602 | <input type="checkbox"/> 050603 |
| <input type="checkbox"/> 050604 | <input type="checkbox"/> 050605 | <input type="checkbox"/> 050607 |



**OCTA GLASS TOP** \$294  
Counter

- 1030(w) x 535(d) x 1200mm(h)
- Lockable door & internal shelf

Available Colours

- |                                 |                                 |                                 |
|---------------------------------|---------------------------------|---------------------------------|
| <input type="checkbox"/> 050401 | <input type="checkbox"/> 050402 | <input type="checkbox"/> 050403 |
| <input type="checkbox"/> 050404 | <input type="checkbox"/> 050405 | <input type="checkbox"/> 050407 |



**OCTA LOCKABLE \$288**

Counter

- 1030(w) x 535(d) x 1000mm(h)
- Lockable door & internal shelf

Available Colours

- |                                 |                                 |                                 |
|---------------------------------|---------------------------------|---------------------------------|
| <input type="checkbox"/> 050201 | <input type="checkbox"/> 050202 | <input type="checkbox"/> 050203 |
| <input type="checkbox"/> 050204 | <input type="checkbox"/> 050205 | <input type="checkbox"/> 050207 |



**OCTA LOCKABLE EXT \$330**

Counter

- 2020(w) x 535(d) x 1000mm(h)
- Lockable door

Available Colours

- |                                 |                                 |                                 |
|---------------------------------|---------------------------------|---------------------------------|
| <input type="checkbox"/> 051701 | <input type="checkbox"/> 051702 | <input type="checkbox"/> 051703 |
| <input type="checkbox"/> 051704 | <input type="checkbox"/> 051705 | <input type="checkbox"/> 051707 |

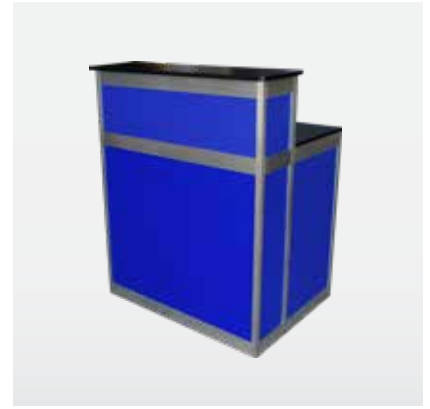

**OCTA REGISTRATION \$304**

Counter

- 1030(w) x 985(d) x 1200/900mm(h)

Available Colours

- |                                 |                                 |                                 |
|---------------------------------|---------------------------------|---------------------------------|
| <input type="checkbox"/> 050101 | <input type="checkbox"/> 050102 | <input type="checkbox"/> 050103 |
| <input type="checkbox"/> 050104 | <input type="checkbox"/> 050105 | <input type="checkbox"/> 050107 |



**OCTA COMPUTER MODULE \$201**

Counter

- 565(w) x 700(d) x 1000mm(h)
- Lockable door & internal shelf

Available Colours

- |                                 |                                 |
|---------------------------------|---------------------------------|
| <input type="checkbox"/> 050301 | <input type="checkbox"/> 050302 |
| <input type="checkbox"/> 050303 | <input type="checkbox"/> 050304 |
| <input type="checkbox"/> 050305 | <input type="checkbox"/> 050307 |



**BALLOT \$118**

Entry Box

- Lockable with entry slot
- Printed Panels / other colours available
- 380(w) x 380(d) x 1000mm(h)

Available Colours

- |                                 |                                 |
|---------------------------------|---------------------------------|
| <input type="checkbox"/> 061501 | <input type="checkbox"/> 061502 |
|---------------------------------|---------------------------------|

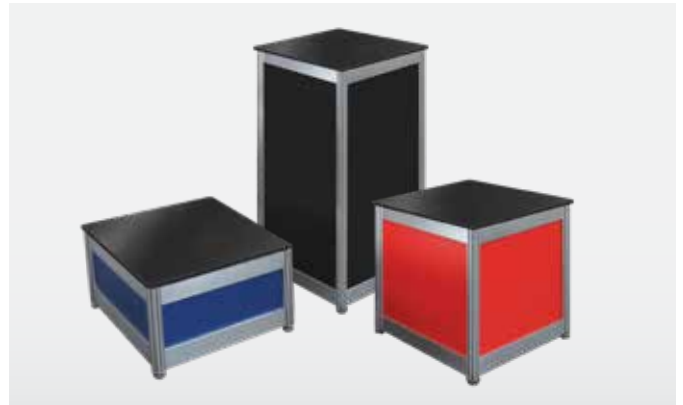

**PLINTHS**

Display

- |                            |                            |                            |
|----------------------------|----------------------------|----------------------------|
| 300mm Plinth \$76          | 600mm Plinth \$95          | 900mm Plinth \$118         |
| 535(w) x 535(d) x 300mm(h) | 535(w) x 535(d) x 600mm(h) | 535(w) x 535(d) x 900mm(h) |

Available Colours

- |                                 |                                 |
|---------------------------------|---------------------------------|
| <input type="checkbox"/> 070201 | <input type="checkbox"/> 070202 |
| <input type="checkbox"/> 070203 | <input type="checkbox"/> 070204 |
| <input type="checkbox"/> 070205 | <input type="checkbox"/> 070207 |

Available Colours

- |                                 |                                 |
|---------------------------------|---------------------------------|
| <input type="checkbox"/> 070301 | <input type="checkbox"/> 070302 |
| <input type="checkbox"/> 070303 | <input type="checkbox"/> 070304 |
| <input type="checkbox"/> 070305 | <input type="checkbox"/> 070307 |

Available Colours

- |                                 |                                 |
|---------------------------------|---------------------------------|
| <input type="checkbox"/> 070401 | <input type="checkbox"/> 070402 |
| <input type="checkbox"/> 070403 | <input type="checkbox"/> 070404 |
| <input type="checkbox"/> 070405 | <input type="checkbox"/> 070407 |



# COUNTER & TABLE GRAPHICS



## MAXIMA RECEPTION

Graphic

- Print size: 965(w) x 1055mm(h)

Front **076101** **\$194**



## MAXIMA DESK EXT

Graphic

- Print size: 965(w) x 1055mm(h)

Front **076201** **\$194**



## MAXIMA LOCKABLE

Graphic

- Print size: 965(w) x 855mm(h)

Front **076001** **\$157**



## OCTA CURVED

Graphic

- Print size: 1527(w) x 880mm(h)

Front **077401** **\$256**



## OCTA CURVED RECEPTION

Graphic

- Top print size: 1527(w) x 250mm(h)
- Base print size: 1527(w) x 780mm(h)

Top **077602** **\$73**  
Base **077601** **\$227**

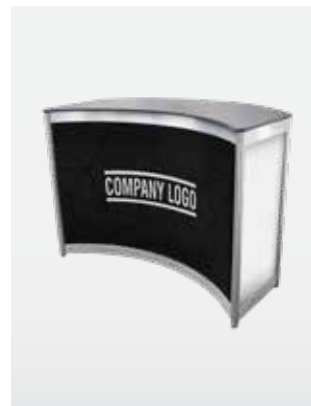

## OCTA CURVED REVERSED

Graphic

- Print size: 1527(w) x 880mm(h)

Front **077901** **\$249**



## OCTA GLASS TOP

Graphic

- Print size: 965(w) x 780mm(h)

Front **077301** **\$143**

**COST IS FOR GRAPHICS ONLY. FURNITURE TO BE ORDERED SEPARATELY.**



### OCTA LOCKABLE

Graphic

- Print size: 965(w) x 880mm(h)

---

Front **077001** **\$162**



### OCTA LOCKABLE EXT

Graphic

- Print size: 965(w) x 880mm(h)

---

Front **077101** **\$162**



### OCTA REGISTRATION

Graphic

- Top print size: 965(w) x 250mm(h)
- Base print size: 965(w) x 780mm(h)

---

|      |               |              |
|------|---------------|--------------|
| Top  | <b>077202</b> | <b>\$44</b>  |
| Base | <b>077201</b> | <b>\$139</b> |



### OCTA COMPUTER MODULE

Graphic

- Print size: 470(w) x 880mm(h)

---

Front **077801** **\$79**



### BALLOT BOX

Graphic

- Print size: 330(w) x 880mm(h)

---

Front **079001** **\$77**



### PLINTHS

Graphic

---

|              |                               |               |             |
|--------------|-------------------------------|---------------|-------------|
| 300mm Plinth | Print size: 470(w) x 180mm(h) | <b>079101</b> | <b>\$26</b> |
| 600mm Plinth | Print size: 470(w) x 480mm(h) | <b>079102</b> | <b>\$52</b> |
| 900mm Plinth | Print size: 470(w) x 780mm(h) | <b>079103</b> | <b>\$77</b> |



### TT TABLES

Graphic

- Laminated to table top

---

|                 |                               |               |              |
|-----------------|-------------------------------|---------------|--------------|
| TT Coffee Table | Print size: 900(w) x 450mm(d) | <b>075301</b> | <b>\$77</b>  |
| TT Square Table | Print size: 750(w) x 750mm(d) | <b>075401</b> | <b>\$107</b> |



### BELLA TABLES

Graphic

- Laminated to table top

---

|                    |                      |               |              |
|--------------------|----------------------|---------------|--------------|
| Bella Table        | Print size: 750mm(d) | <b>075001</b> | <b>\$107</b> |
| Bella Bar Table    | Print size: 750mm(d) | <b>075101</b> |              |
| Bella Coffee Table | Print size: 750mm(d) | <b>075201</b> |              |

**COST IS FOR GRAPHICS ONLY. FURNITURE TO BE ORDERED SEPARATELY.**

Hire rates do not include Cartage, Damage Waiver or GST, and are for the duration of the exhibition.

# FURNITURE | BROCHURE HOLDERS



**A4 ACRYLIC HOLDER** \$26  
Brochure Holder

Wall Mount  **060601**

Desk Mount  **062001**



**A4 ACRYLIC HOLDER** \$43  
Brochure Holder

- Present brochures in a staggered layout

Desk Mount  **067116**



**RAMPED** \$124  
Brochure Holder

- 290(w) x 290(d) x 1200mm(h)
- Black frame/mesh & Coloured infills

Available Colours

**072501**  **072502**  **072503**  
 **072505**

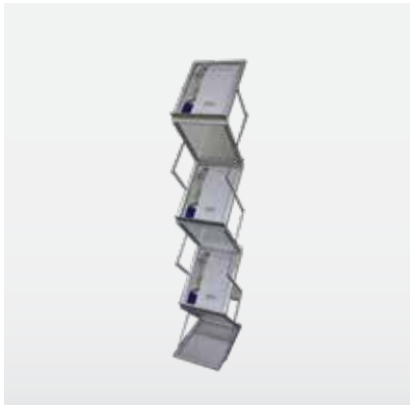

**FOLDING** \$121  
Brochure Holder

- A4 brochure holder
- Double-sided
- 1430mm height with 6 shelves

Item Code  **060808**



**ZIG-ZAG** \$124  
Brochure Holder

- A4 brochure holder
- Double-sided

1430mm (h) w/6 Shelves  **060701** \$124  
1665mm (h) w/5 Shelves  **060702** \$124



**MODE SHELF UNIT** \$184  
Brochure Holder

- 5 Shelves available as flat or at 45 degrees

Available Colours

**067901**  **067902**  **067903**  
 **067904**  **067905**  **067907**  
 **067911**



# FURNITURE | DISPLAY PODS



## OCTA DEMO \$1008

Pod - Includes digital print sign panel

- 1030(w) x 660(d) x 2440mm(h)
- Graphic: 1030mm (w) x 250mm (h)
- Audio-visual ordered separately

Available Colours

- 051401     051402     051403  
 051405



## OCTA CURVED DEMO \$916

Pod - Includes digital print sign panel

- 1030(w) x 800(d) x 2440mm(h)
- Graphic: 1078mm (w) x 300mm (h)
- Audio-visual ordered separately

Available Colours

- 051801     051802     051803  
 051805



## OCTA INFO \$410

Pod - Includes digital print sign panel

- 1440(w) x 670(d) x 2440mm(h)
- Graphic: 1532mm (w) x 240mm (h)
- Open at back

Available Colours

- 051901     051902     051903  
 051905



## OCTA DOUBLE \$530

Pod - Includes digital print sign panel

- 565 (w) x 1330(d) x 2000mm(h)
- Graphic: 470mm (w) x 864mm (h)
- Double-sided with lockable doors
- Audio-visual ordered separately

Available Colours

- 052001     052002     052003  
 052005

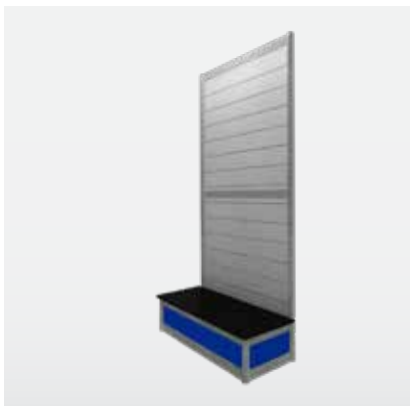

## OCTA SLATWALL \$227

Pod

- 1030(w) x 410(d) x 2440mm(h)
- Slatwall fittings ordered separately

Available Colours

- 064701     064702     064703  
 064705



## 2) ACRYLIC SHELF



## 3) HANGER



## 4) PEG



## 5) WATERFALL

## SLATWALL

Fittings

- Display fittings for slat wall pods or slat wall panels

|                  |        |      |              |        |      |
|------------------|--------|------|--------------|--------|------|
| 1) Clothes Rail  | 071416 | \$31 | 4) Peg       | 071516 | \$8  |
| 2) Acrylic Shelf | 071201 | \$31 | 5) Waterfall | 071016 | \$21 |
| 3) Hanger        | 071316 | \$11 |              |        |      |

# FURNITURE | DISPLAY PANELS & PLINTHS

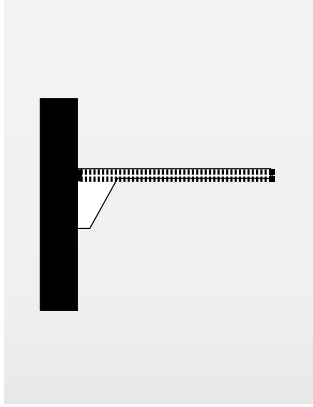

## FLAT WALL

Shelving

- 1030(w) x 300mm(d) x Approx. 15mm(h)
- Aluminium front lip
- Fits onto corinthian structure

Set of 3 **072116** **\$178**  
Extra Shelf **072119** **\$60**

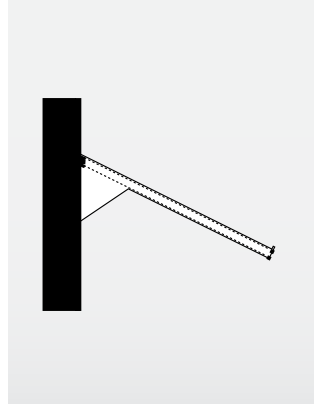

## ANGLED WALL

Shelving

- 1030(w) x 300mm(d) x Approx. 15mm(h)
- Aluminium front lip
- Fits onto corinthian structure

Set of 3 **072117** **\$178**  
Extra Shelf **072118** **\$60**

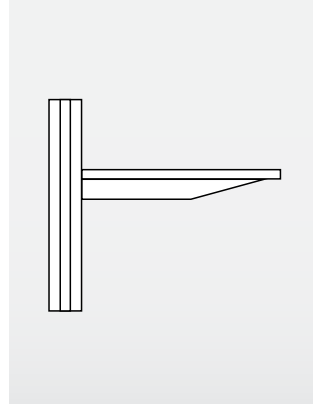

## FLAT OCTA

Shelving

- 1030(w) x 300mm(d)
- Fits onto octanorm structure

Set of 3 **072201** **\$178**  
Extra Shelf **072203** **\$60**

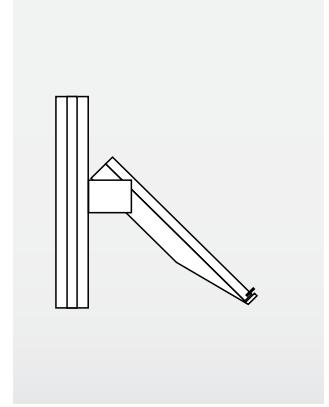

## ANGLED OCTA

Shelving

- 1030(w) x 300mm(d)
- Adjustable angle
- Fits onto octanorm structure

Set of 3 **072202** **\$178**  
Extra Shelf **072200** **\$60**



## SMALL LOGO

**\$79**

Shelving

- 600(w) x 300(d) x 510mm(h)
- Glass Shelves

Item Code  **072602**



## MEDIUM LOGO

**\$111**

Shelving

- 600(w) x 300(d) x 900mm(h)
- Glass Shelves

Item Code  **072702**



## LARGE LOGO

**\$147**

Shelving

- 600(w) x 300(d) x 1290mm(h)
- Glass Shelves

Item Code  **072802**



## HORIZONTAL

**\$101**

Panel

- Freestanding or linked
- Velcro-compatible
- 2000(h)/2440(h) x 2400mm(w)

Available Colours

**070802**  **070809**



## VERTICAL

**\$101**

Panel

- Freestanding or linked
- Velcro-compatible
- 940(w) x 2400mm(h)/2000mm(h)

Available Colours

**070902**  **070909**



## CORINTHIAN

**\$101**

Panel

- Freestanding or linked
- Velcro-compatible
- 1000(w) x 2400mm(h)

Available Colours

**072302**  **072305**



# FURNITURE | BUSINESS ACCESSORIES



## EASEL \$63

*Display*

- Display easel
- Adjustable height

Item Code ■ 062104



## WHITE BOARD

*Single Item*

- 1200(w) x 900mm(h)
- Wall-mountable
- Can be used with easel (ordered separately)

Board **064401** **\$102**  
Pens **064503** **\$21**



## WHITE BOARD

*Freestanding*

- 700(w) x 1000mm(h)
- 960(w) x 1780mm(h)

Board **064501** **\$102**  
Pens **064503** **\$21**



## WHITE BOARD

*Freestanding*

- 1200(w) x 900mm(h)
- 1300(w) x 1750mm(h)

Board **065201** **\$121**  
Pens **064503** **\$21**



## CHART

*Freestanding*

- 700(w) x 1000mm(h)
- 960(w) x 1780mm(h)

Chart **064501** **\$102**  
Pens **064503** **\$21**  
Paper **064502** **\$79**



## BARREL

**\$209**

*Mobile Entry Barrel*

- Rotating barrel
- Lockable door hatch
- White frame with castors
- 700(w) x 430(d) x 1100mm(h)

Item Code □ 062501



## BOWL \$64

*Glass Bowl*

- Clear, transparent glass bowl
- Perfect for business cards

Item Code □ 061901



# FURNITURE | OUTDOOR ACCESSORIES & BARRIERS



## BETIS SETTING

\$309

Setting

- 1 x Square Cafe table (760mm height)
- 4 x Betis chairs

Available Colours

■ 090302 ■ 090309



## MIMOSA LOUNGE

\$260

Seating

- Woven plastic base
- 1320(w) x 660(d) x 640mm(h)

Available Colours

■ 031715



## PICKET FENCE

\$130

Outdoor Accessory

- Sturdy painted wooden fencing for a whimsical outdoor look
- Each fence is hired in 1.8m sections

Item Code

□ 062318



## JASPER UMBRELLA

\$85

Outside Umbrella

- Wind-up crank to open and close canopy
- 50+| UPF protection rating
- Secures into a table or base

Item Code

■ 067520



## MARQUEE UMBRELLA

\$85

Outside Umbrella

- Crank handle to open and close canopy
- 50+| UPF protection rating
- Lightweight aluminium and steel frame

Item Code

■ 067620



## ROPE

\$38

Barrier

- 1500mm rope length
- Chrome Post not included

Available Colours

■ 061403 ■ 061402



## CHROME POST/A4 HOLDER

Post / Holder

- Items compatible with one another
- Chrome Post and A4 Holder to be ordered separately

A4 Holder Only **062301 \$35**  
Chrome Post Only **061416 \$31**



## TENSA & POST

\$69

Barrier

- Chrome post retractable belt
- 1500mm length
- 2 sets minimum required

Available Colours

■ 062316 ■ 062312



## OCTA

\$124

Barrier

- Digital Print Front (078901) + \$254
- 785(h) x 2000mm span (approx)
- Can link to form fence

Available Colours

□ 072401 ■ 072402  
■ 072403 ■ 072405

# FURNITURE | HOSPITALITY



## BAR \$151

Fridge

- Bar fridge with mini freezer
- 500(w) x 555(d) x 850mm(h)

Item Code **060101**



## GLASS DISPLAY \$265

Fridge

- Glass door display fridge
- Internal light
- 2x adjustable shelves
- 500(w) x 560(d) x 755mm(h)

Item Code **062601**



## STAINLESS STEEL \$545

Fridge

- Full-height fridge
- Glass front door
- 700(w) x 600(d) x 1950mm(h)

Item Code **066708**



## WHITE FRIDGE \$304

Fridge & Freezer

- Full-height fridge
- Separate freezer at bottom
- 600(w) x 600(d) x 1715mm(h)

Item Code **060201**



## WATER COOLER

Cooler

- Water cooler
- 300(w) x 300(d) x 1000mm(h)
- Water bottles and cups ordered separately

|               |               |       |
|---------------|---------------|-------|
| Cooler        | <b>064101</b> | \$166 |
| Bottles       | <b>064201</b> | \$22  |
| Cups (50 qty) | <b>064301</b> | \$21  |



## WATER URN \$76

Hot Water - 8 Litre

- Electric hot water urn
- 8 litre capacity

Item Code **064001**

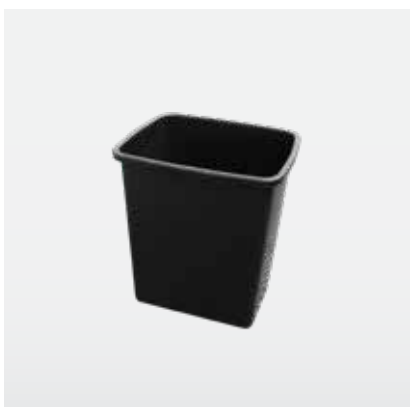

## WASTE BASKET \$21

Small Bin

- Plastic waste basket at 350mm(h)

Item Code **060502**

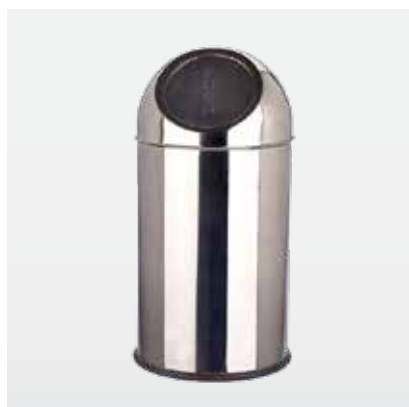

## PUSH LID \$43

Bin

- Stainless steel
- Push lid top
- 545mm height

Item Code **060516**

# FURNITURE | FASHION DISPLAYS



**ANGLED** \$95

*Hanger*

- Chrome 4-way clothes hanger
- Height adjustable arms

Item Code ■ 060316



**LEVEL** \$95

*Hanger*

- Chrome 4-way clothes hanger
- Height adjustable arms

Item Code ■ 060416



**MOBILE** \$95

*Hanger*

- Portable clothes hanger
- On castors
- Adjustable height

Item Code ■ 064816



**COAT** \$77

*Stand*

- 1745(h) x 330mm(d)
- 6 x hangers

Item Code ■ 063316



**CHEVAL** \$101

*Mirror*

- 370(w) x 490(d) x 1435mm(h)
- Silver frame

Item Code ■ 063208



# FURNITURE | GLASS DISPLAYS

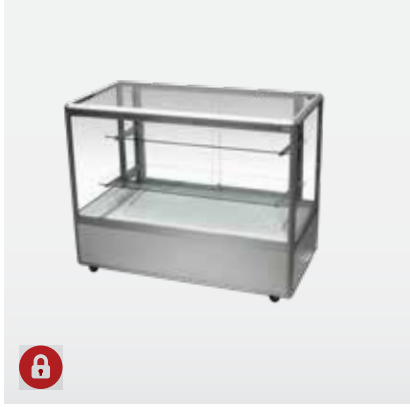

**3/4 GLASS** \$350

Showcase

- 1200(w) x 600(d) x 900mm(h)
- Lockable glass top section
- Lockable base cupboard

Item Code **070109**

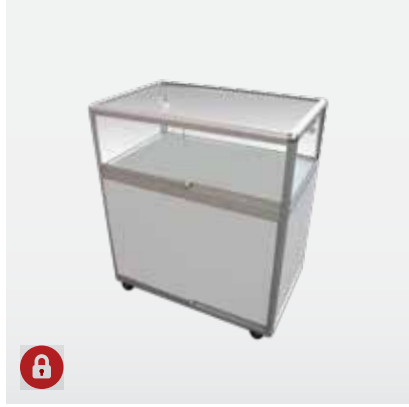

**DEVINO** \$350

Showcase

- measurements on request
- Lockable glass top section
- Lockable base cupboard

Item Code **070101**

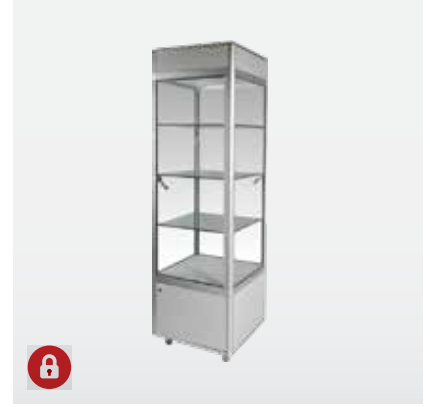

**GLASS TOWER** \$410

Showcase

- 600(w) x 600(d) x 1800mm(h)
- Lockable glass top section
- Lockable base cupboard
- Lights in top section

Item Code **070102**

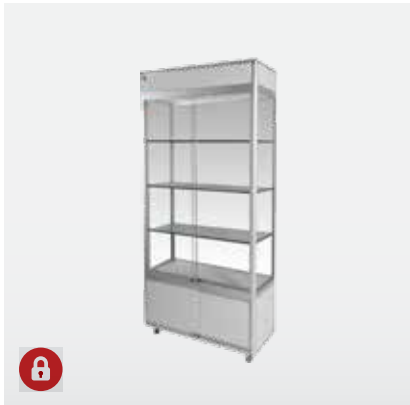

**GLASS WINDOW** \$500

Showcase

- 1000(w) x 450(d) x 1800mm(h)
- Lockable glass top section
- Lockable base cupboard

Item Code **070105**

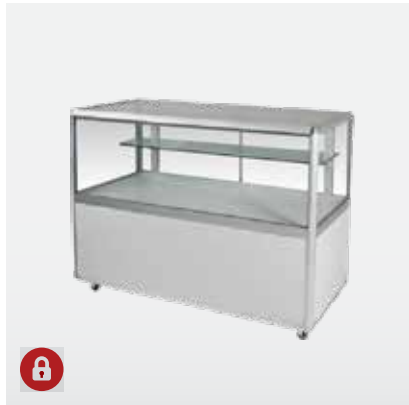

**HALF GLASS** \$350

Showcase

- 1200(w) x 600(d) x 950mm(h)
- Lockable glass top section
- Lockable base cupboard
- With light

Item Code **070107**

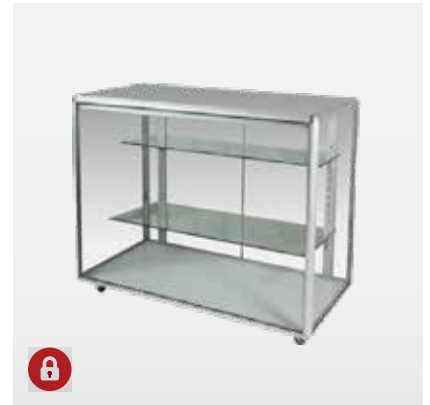

**FULL GLASS** \$380

Showcase

- 1200(w) x 600(d) x 950mm(h)
- Lockable glass top section
- With light

Item Code **070108**



# AUDIO / VISUAL | SCREENS & STANDS



## 82" LCD FULL HD

TV Screen

- Desk mounted (comes standard)
- Wall-mount or Plasma stand (order separately)

|          |               |  |
|----------|---------------|--|
| 1-2 days | <b>084801</b> |  |
| 3 days   | <b>084802</b> |  |
| 4-7 days | <b>084803</b> |  |

|               |
|---------------|
| <b>\$2594</b> |
| <b>\$3134</b> |
| <b>\$3760</b> |



## 65" LCD FULL HD

TV Screen

- Desk mounted (comes standard)
- Wall-mount or Plasma stand (order separately)

|          |               |  |
|----------|---------------|--|
| 1-2 days | <b>084301</b> |  |
| 3 days   | <b>084302</b> |  |
| 4-7 days | <b>084303</b> |  |

|               |
|---------------|
| <b>\$1068</b> |
| <b>\$1353</b> |
| <b>\$1675</b> |



## 55" LCD FULL HD

TV Screen

- Desk mounted (comes standard)
- Wall-mount or Plasma stand (order separately)

|          |               |               |
|----------|---------------|---------------|
| 1-2 days | <b>081701</b> | <b>\$925</b>  |
| 3 days   | <b>081702</b> | <b>\$1238</b> |
| 4-7 days | <b>081703</b> | <b>\$1583</b> |



## 43" LCD FULL HD

TV Screen

- Desk mounted (comes standard)
- Wall-mount or Plasma stand (order separately)

|          |               |               |
|----------|---------------|---------------|
| 1-2 days | <b>081611</b> | <b>\$714</b>  |
| 3 days   | <b>081612</b> | <b>\$928</b>  |
| 4-7 days | <b>081613</b> | <b>\$1104</b> |



## 40" LCD FULL HD

TV Screen

- Desk mounted (comes standard)
- Wall-mount or Plasma stand (order separately)

|          |               |               |
|----------|---------------|---------------|
| 1-2 days | <b>081601</b> | <b>\$668</b>  |
| 3 days   | <b>081602</b> | <b>\$871</b>  |
| 4-7 days | <b>081603</b> | <b>\$1038</b> |

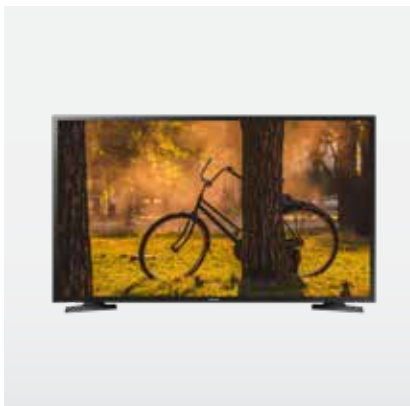

## 32" LCD FULL HD

TV Screen

- Desk mounted (comes standard)
- Wall-mount or Plasma stand (order separately)

|          |               |              |
|----------|---------------|--------------|
| 1-2 days | <b>080601</b> | <b>\$619</b> |
| 3 days   | <b>080602</b> | <b>\$747</b> |
| 4-7 days | <b>080603</b> | <b>\$871</b> |



## 26" LCD FULL HD

TV Screen

- Desk mounted (comes standard)
- Wall-mount or Plasma stand (order separately)

|          |               |              |
|----------|---------------|--------------|
| 1-2 days | <b>082701</b> | <b>\$404</b> |
| 3 days   | <b>082702</b> | <b>\$471</b> |
| 4-7 days | <b>082703</b> | <b>\$527</b> |

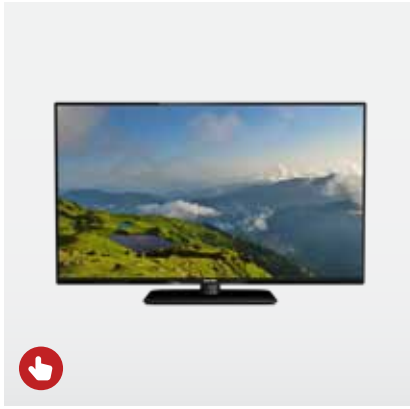

### 40" TOUCHSCREEN

TV Touchscreen

- Desk mounted (comes standard)
- Wall-mount or Plasma stand (order separately)

|          |               |               |
|----------|---------------|---------------|
| 1-2 days | <b>084701</b> | <b>\$941</b>  |
| 3 days   | <b>084702</b> | <b>\$1060</b> |
| 4-7 days | <b>084703</b> | <b>\$1190</b> |

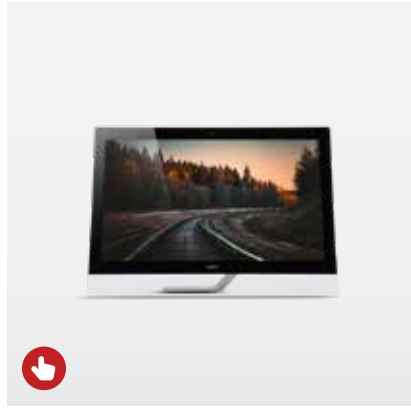

### 27" TOUCHSCREEN

TV Touchscreen

- Desk mounted (comes standard)
- Wall-mount or Plasma stand (order separately)

|          |               |              |
|----------|---------------|--------------|
| 1-2 days | <b>084704</b> | <b>\$643</b> |
| 3 days   | <b>084705</b> | <b>\$756</b> |
| 4-7 days | <b>084706</b> | <b>\$846</b> |



### 15.6" PC LAPTOP

Laptop

- Uses Windows operating system

|          |               |              |
|----------|---------------|--------------|
| 1-2 days | <b>083101</b> | <b>\$234</b> |
| 3 days   | <b>083102</b> | <b>\$328</b> |
| 4-7 days | <b>083103</b> | <b>\$407</b> |



### LILLIPAD FLOOR STAND

iPad Holder

- iPad Floor Stand (iPad not included - order iPad separately)

|          |               |              |
|----------|---------------|--------------|
| 1-2 days | <b>083501</b> | <b>\$156</b> |
| 3 days   | <b>083502</b> | <b>\$203</b> |
| 4-7 days | <b>083503</b> | <b>\$240</b> |



### LILLIPAD DESK STAND

iPad Holder

- iPad Desk Stand (iPad not included - order iPad separately)

|          |               |              |
|----------|---------------|--------------|
| 1-2 days | <b>083401</b> | <b>\$156</b> |
| 3 days   | <b>083402</b> | <b>\$203</b> |
| 4-7 days | <b>083403</b> | <b>\$240</b> |



### PROJECTOR

Digital

- 3000 lumens of brightness
- Connects to your computer

|          |               |              |
|----------|---------------|--------------|
| 1-2 days | <b>084501</b> | <b>\$390</b> |
| 3 days   | <b>084502</b> | <b>\$570</b> |
| 4-7 days | <b>084503</b> | <b>\$790</b> |



### WALL MOUNT PULL DOWN

Pull Down Screen

- Screen size approx 2.0m x 2.4m

|          |               |              |
|----------|---------------|--------------|
| 1-2 days | <b>083201</b> | <b>\$117</b> |
| 3 days   | <b>083202</b> | <b>\$132</b> |
| 4-7 days | <b>083203</b> | <b>\$142</b> |



### KEYBOARD & MOUSE \$50

Peripheral

- Plugs into your computer through a USB and Plug & Play software.

Item Code **082201**



### 43" SCREEN & STAND

Screen & Stand

- Includes 43" LCD screen
- Includes shelf
- Landscape or portrait display

|          |               |               |
|----------|---------------|---------------|
| 1-2 days | <b>082101</b> | <b>\$828</b>  |
| 3 days   | <b>082102</b> | <b>\$1038</b> |
| 4-7 days | <b>082103</b> | <b>\$1188</b> |



### 55" SCREEN & STAND

Screen & Stand

- Includes 55" LCD screen
- Includes shelf
- Landscape or portrait display

|          |               |               |
|----------|---------------|---------------|
| 1-2 days | <b>082121</b> | <b>\$1015</b> |
| 3 days   | <b>082122</b> | <b>\$1347</b> |
| 4-7 days | <b>082123</b> | <b>\$1671</b> |



### SOUND BAR

Audio

- Bluetooth and 3.5mm audio jack connectivity
- Can be both USB-powered or wirelessly charged (6hr battery life)

|          |               |             |
|----------|---------------|-------------|
| 1-2 days | <b>081020</b> | <b>\$76</b> |
| 3 days   | <b>081021</b> | <b>\$87</b> |
| 4-7 days | <b>081022</b> | <b>\$98</b> |

# AUDIO / VISUAL | LIGHTING / ELECTRICAL | STAGING



## BLU-RAY

Player

- High-definition Blu-Ray player

|          |               |              |
|----------|---------------|--------------|
| 1-2 days | <b>081501</b> | <b>\$122</b> |
| 3 days   | <b>081502</b> | <b>\$132</b> |
| 4-7 days | <b>081503</b> | <b>\$144</b> |



## HDMI - 2 WAY

Splitter

- 2-way HDMI splitter
- Run up to 2 screens

|          |               |              |
|----------|---------------|--------------|
| 1-2 days | <b>083001</b> | <b>\$114</b> |
| 3 days   | <b>083002</b> | <b>\$138</b> |
| 4-7 days | <b>083003</b> | <b>\$167</b> |



## HDMI - 4 WAY

Splitter

- 4-way HDMI splitter
- Run up to 4 screens

|          |               |              |
|----------|---------------|--------------|
| 1-2 days | <b>082901</b> | <b>\$127</b> |
| 3 days   | <b>082902</b> | <b>\$149</b> |
| 4-7 days | <b>082903</b> | <b>\$178</b> |



## EXTENSION CORD

POA

Power

- Power supply to a 10 amp powerpoint

Item Code ■ **009011**



## 4 WAY BOARD

\$33

Power

- Multi-outlet power board

Item Code ■ **009009**



## SWITCHBOARD

Power

- Various switchboards

|                                  |                 |              |
|----------------------------------|-----------------|--------------|
| 3-phase distribution switchboard | ■ <b>009002</b> | <b>\$258</b> |
| 20 amp 3-phase                   | ■ <b>009005</b> | <b>\$464</b> |
| 32 amp 3-phase                   | ■ <b>009006</b> | <b>\$721</b> |



## POWER SUPPLY

Power

|       |               |              |
|-------|---------------|--------------|
| 10amp | <b>009001</b> | <b>\$149</b> |
| 15amp | <b>009053</b> | <b>\$196</b> |
| 20amp | <b>009003</b> | <b>\$263</b> |







**32w ON-ARM**     **\$144**

*LED On-Arm Light*

- 32w arm light

*Item Code*      **009035**



**48w ON-ARM**     **\$160**

*LED On-Arm Light*

- 48w arm light

*Item Code*      **009038**

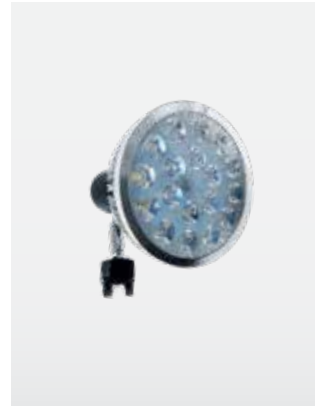

**28w SPOTLIGHT**     **\$134**

*LED Track Spotlight*

- LED track spotlight

*Item Code*      **009023**



**PAR CAN**     **POA**

*Spotlight*

- 64w LED PAR CAN

*Item Code*      **E216**



**LED STRIP**     **POA**

*Custom Lighting*

- Adhesive LED strip
- Can display a variety of colours

*Item Code*      **E218**



**STORM LAMP**     **\$93**

*Floor Lamp*

*Item Code*      **068101**

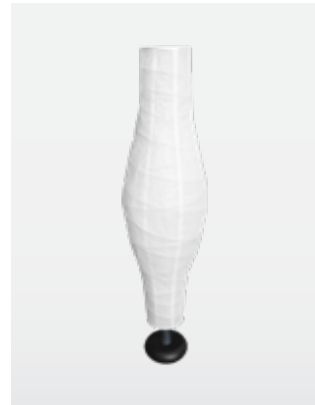

**DUDERO**     **\$93**

*Floor Lamp*

*Item Code*      **068201**



**SAMTID**     **\$103**

*Floor Lamp*

*Item Code*      **068301**



**STAGE**

*1m x 1m*

- 1000 x 1000mm
- With black edge trim
- Carpet ordered separately

300mm(h) **071601**     **\$78**  
600mm(h) **071602**     **\$101**



**STAGE**

*2m x 1m*

- 2000 x 1000mm
- With black edge trim

300mm(h) **071701**     **\$104**  
600mm(h) **071702**     **\$114**  
900mm(h) **071703**     **\$126**



**STAGE**

*Steps*

- 1000(w) x 430(d) x 400(h)mm
- For 600mm height stage units
- Black painted finish

Steps **071802**     **\$78**

# SIGN FRAMES



## REFRAME LIGHTBOX

*Lightbox*

- 1000mm(w) x 2000mm(h)
- Double-side print
- Purchase item
- Other sizes available - price on application

Reframe Lightbox      **063301**      **\$1700**

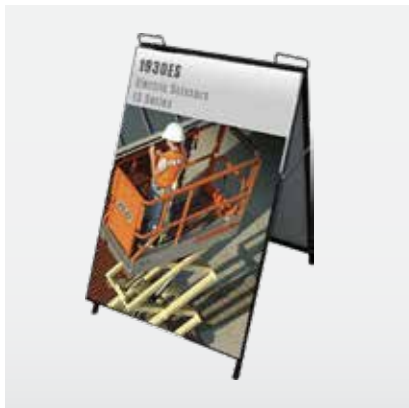

## A-FRAME

*Sign Holder*

- Insert size: 600(w) x 900mm(h)
- Single-sided or double-sided

Sign Holder Only      **065001**      **\$108**  
Single Print      **078101**      **\$105**

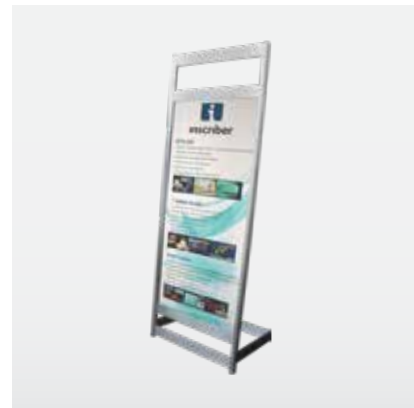

## OCTA TILTED

*Sign Holder*

- Panel size: 675(w) x 1500mm(h)
- Single-sided only

Sign Holder Only      **063001**      **\$126**  
Single Print      **078201**      **\$187**



## M-BOARD

*Sign Holder*

- 10mm Foamcore sign into M-Board Base
- Price is for single sided print. Price for double sided print available upon request.

600mm x 1850mm      **067809**      **\$341**  
1000mm x 2000mm      **067909**      **\$569**

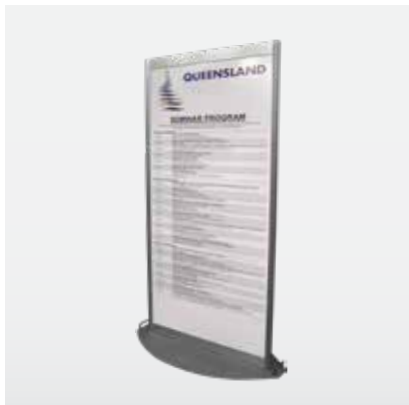

## OCTA FLAT

*Sign Frame*

- Single or Double Sided
- 2m Panel Size: 965(w) x 2000mm(h)
- 2.5m Panel Size: 965(w) x 2320mm(h)

2m Frame Only      **062801**      **\$144**  
2m Single Print      **078401**      **\$368**  
2.5m Frame Only      **062802**      **\$157**  
2.5m Single Print      **078402**      **\$426**



## OCTA CURVED

*Sign Frame*

- Single or Double Sided
- 2m Panel Size: 1078(w) x 1880mm(h)
- 2.5m Panel Size: 1078(w) x 2320mm(h)

2m Frame Only      **062901**      **\$144**  
2m Single Print      **078501**      **\$386**  
2.5m Frame Only      **062902**      **\$157**  
2.5m Single Print      **078502**      **\$477**



## SMALL CHROME

*Sign Holder*

- Insert size: 290(w) x 420mm(h)
- Overall height: 1490mm

Frame Only      **060916**      **\$88**  
Single Print      **078601**      **\$24**

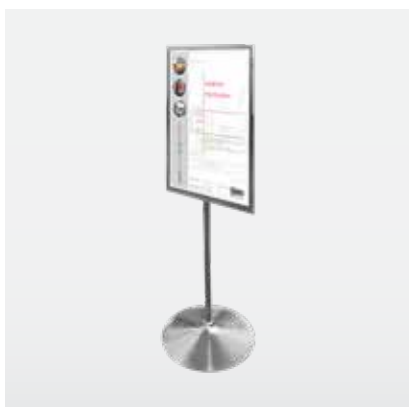

## A2 CHROME

*Sign Holder*

- Insert size: 420(w) x 594mm(h)
- Overall height: 1560mm

Frame Only      **060917**      **\$96**  
Single Print      **078602**      **\$47**



## LARGE CHROME

*Sign Holder*

- Insert size: 500(w) x 750mm(h)
- Overall height: 1560mm

Frame Only      **061016**      **\$104**  
Single Print      **078701**      **\$71**

# FAUX POTTED PLANTS & FOLIAGE



## BAMBOO PLANT

Pot Plant

Large (1700mm) **068503** \$103  
 Medium (630mm) **068507** \$81



## VARIEGATED FICUS

Pot Plant

Large (1700mm) **067346** \$103  
 Medium (900mm) **068501** \$92

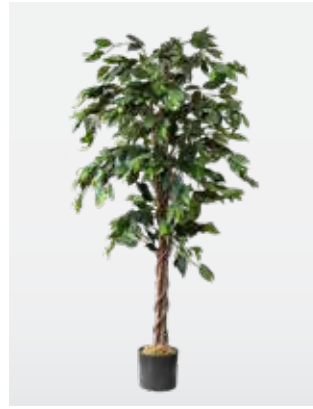

## DARK LEAF FICUS \$103

Pot Plant

- 1700mm high

Item Code **068509**

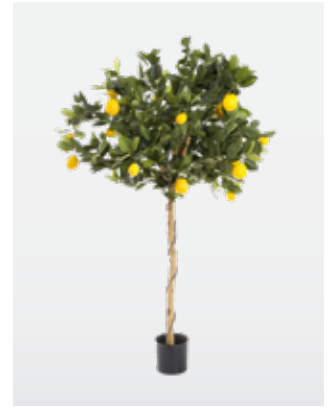

## LEMON TREE \$103

Pot Plant

- 1200mm high

Item Code **068510**



## MONSTERA

\$92

Pot Plant

- 900mm high

Item Code **068514**

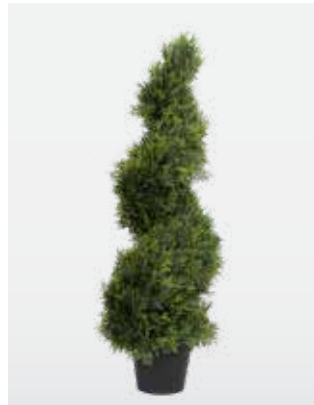

## SPIRAL HEDGE

\$163

Pot Plant

- 1800mm high

Item Code **068506**



## LOOSE IVY

\$21

Foliage

- Per linear meter

Item Code **068511**

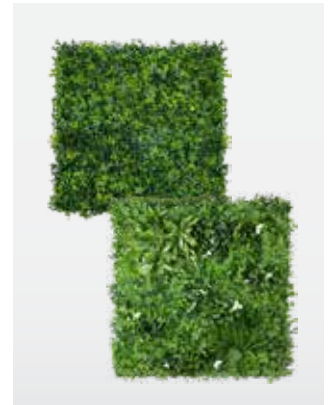

## GREEN WALL

Foliage

- Per square meter

Spring Sensation **068512** \$195<sub>p/m²</sub>  
 White Oasis **068513** \$195<sub>p/m²</sub>



## FERNS & PALMS

Foliage

|  |               |      |                                   |               |      |
|--|---------------|------|-----------------------------------|---------------|------|
| <b>1)</b> Boston Fern (650mm high)     | <b>068504</b> | \$81 | <b>4)</b> Ruffle Fern (450mm)     | <b>066613</b> | \$81 |
| <b>2)</b> Leather Fern (470mm high)    | <b>066609</b> | \$81 | <b>5)</b> Cycad Palm (450mm high) | <b>066607</b> | \$81 |
| <b>3)</b> Margaritum Fern (600mm high) | <b>066611</b> | \$81 |                                   |               |      |

## DEFINITIONS & STANDARD CONDITIONS OF HIRE

- 1. DEFINITIONS** "Exhibit" means Exhibit Systems Pty Ltd ABN 78 091 935 116;  
"Customer" means the person or entity identified as such in the relevant Hire Agreement;  
"Hire Agreement" means the approved quote/order/invoice for the hire of the Goods.
- 2. CANCELLATIONS** If a Customer cancels an order or hire after the Goods have been delivered or installed by Exhibit, the Customer is liable for and must still pay the full charges under the Hire Agreement to Exhibit.  
If a Customer cancels an order or hire less than five (5) days before the Goods have been delivered or installed by Exhibit, the Customer is liable for and must still pay 50% of the charges under the Hire Agreement. If a Customer cancels an order or hire less than fourteen (14) days before the Goods have been delivered or installed by Exhibit, the Customer is liable for and must still pay 25% of the charges under the Hire Agreement.  
Regardless of when cancellation occurs, for any design time and production elements, including graphics, that are already produced or in production, full payment is required. This includes any materials sourced for production.
- 3. CARTAGE, DAMAGE WAIVER, LATE ORDERS & ONSITE ORDERS** In addition to the hire charges, the Customer must pay:  
(a) cartage fees at a rate of 27% of the hire charges;  
(b) damage waiver fees at a rate of 8% of the hire charges;  
(c) electrical delivery & installation fee at a rate of 35% of electrical charges;  
(d) if payment is made by credit card, a credit card surcharge of 1.8% +GST;  
(e) where the order is placed after an exhibition deadline date or after the commencement of installation, a late order surcharge of 25% of the hire charges.
- 4. PRICES & CHARGES** Subject to change without notice but will not be changed after receipt of order & confirmation payment. All quoted rates are for the duration of the event (maximum 7 days). All hire items are excluding GST and will attract 10% tax.
- 5. DELIVERY & PICKUP** All goods will be delivered the day or morning prior to opening and must be available for collection immediately following closure of the event. It is the Customer's responsibility to ensure it does not leave any of its property or chattels in or on the Goods immediately prior to the return or collection of the Goods & Exhibit will not be liable to the Customer for any loss.
- 6. TERMS OF PAYMENT** Payment terms are strictly seven days from receipt of invoice or immediate payment if event is within seven days of order
- 7. DISPARITY IN ORDER** Please notify our staff onsite of any disparity to your order. No claims will be recognised after the event.

## GENERAL TERMS AND CONDITIONS - HIRE AGREEMENT



- The Goods are hired to the Customer by Exhibit for the Hire Period on the terms of the Hire Agreement.
- The Customer acknowledges that Exhibit retains title and ownership of the Goods (despite any insolvency of the Customer) and the Customer and Exhibit expressly agree that the Goods will not, and it is not intended that Goods will become a fixture. The right of the Customer to use the Goods is as bailee only on the terms of the relevant Hire Agreement.
- The Customer must pay Exhibit the hire charges at the rates set out in the Hire Agreement and any additional charges as specified under the Hire Agreement. The Customer is not entitled to any discount or rebate if the Goods are not used by the Customer for any part of the Hire Period.
- The Customer will be liable for stamp/hire duty, GST and all other applicable taxes, duties, levies, penalties, and any other government charges imposed under the Hire Agreement.
- Unless Exhibit has otherwise agreed in writing, the Customer must pay all fees, charges, and costs under the Hire Agreement before any of the Goods are delivered or installed by Exhibit.**
- If the Customer requires Exhibit to deliver, collect or install the Goods, the Customer will be liable for the cost of delivery, collection, or installation. Exhibit will not be responsible for any delays in delivery or installation or failure to deliver due to causes beyond its control including but not limited to acts of God, war, terrorism, mobilisation, civil commotion, riots, embargoes, orders or regulations or governments of any relevant jurisdiction, fires, floods, strikes, lockouts or other labour difficulties, shortages of or inability to obtain shipping space or land transportation.
- The Customer must notify Exhibit of any problems with the Goods upon delivery or installation, failing which the Customer may not make any claim in respect of the Goods or under the Hire Agreement.
- The Customer consents to Exhibit inspecting the Goods from time to time whilst the Goods are in the Customer's possession or control. For this purpose, the Customer and Exhibit agree that during the period of any inspection by Exhibit, Exhibit will have exclusive possession and control of the Goods to the exclusion of any other person and may alter, test, repair or replace all or any of the Goods with other Goods.
- Obligations of the Customer: In the event that the Goods become unsafe to use, break down or fail the Customer will:
  - Immediately stop using the Goods and notify Exhibit;
  - Take all steps necessary to prevent injury occurring to persons or property as a result of the condition of the Goods;
  - Take all steps necessary to prevent any further damage to the Goods, and
  - Not repair or attempt to repair the Goods without Exhibit's written consent.
- Exhibit may terminate the Hire Agreement immediately by notice to the Customer, if:
  - a Default occurs;
  - The Customer breaches any term of the Hire Agreement
  - The Customer takes any action, permits, or causes any action to be taken which prejudices Exhibit's rights in the Goods; or
  - In the absolute opinion of Exhibit, the Customer becomes unable to pay the Customer's debts as and when they become due, is insolvent or otherwise ceases to carry on business or otherwise ceases to carry on business.
- The Customer is responsible for the Goods and associated accessories whilst in the Customer's possession or control. If the Goods are lost, stolen or deliberately damaged whilst in the Customer's possession or control, the Customer will be liable for and immediately pay on demand:
  - Any costs incurred by Exhibit in repairing or replacing the Goods, and
  - Any other costs incurred by Exhibit as a result of the loss, theft or damage of the Goods, including applicable hire charges when the damage was caused by the negligence or act or omission of the Customer
- If the Customer is in breach of the Hire Agreement or if Exhibit has terminated the Hire Agreement, Exhibit may take any step, including legal action, to recover the Goods, including by entering the Customer's premises or such premises where the Goods are located, and the Customer irrevocably authorises Exhibit and its agents to do so. The Customer indemnifies Exhibit in respect of any claims, damages or expenses arising out of any action taken under this clause.





## **SYDNEY**

-  +61 2 9982 5511
-  PO Box 801, Freshwater NSW 2096
-  5 Boola Place, Cromer NSW 2099
-  [sales@exhibitsystems.com.au](mailto:sales@exhibitsystems.com.au)
-  [www.exhibitsystems.com.au](http://www.exhibitsystems.com.au)

## **BRISBANE / GOLD COAST**

-  +61 7 3805 1543
-  25 High Road, Bethania Qld 4205

## **MELBOURNE**

-  +61 3 8375 1638
-  37 Sunline Drive, Truganina VIC 3029

**24** YEARS  
working  
on your side