

CATALOGUE

products & service

2 0 2 4





WINNER BEST CUSTOM STAND



YOUNG ACHIEVER AWARD



ABOUT EXHIBIT SYSTEMS

Exhibit Systems has serviced the exhibition and events industry throughout Australia since its formation in March 2000. The Company has grown into one of Australia's most trusted exhibition and event providers servicing hundreds of exhibitions and events annually. Products & Services include modular exhibition booths, custom stand design and production, electrics, furniture and audio-visual, design and project management, right through to logistical support. With branches in: Sydney (Head Office), Melbourne and Brisbane, Exhibit Systems can offer creative solutions for any event.

For more information, please contact one of our Account Managers today.

SYDNEY



+61 2 9982 5511



PO Box 801, Freshwater NSW 2096



5 Boola Place, Cromer NSW 2099



sales@exhibitsystems.com.au



www.exhibitsystems.com.au

BRISBANE / GOLD COAST



+61 7 3805 1543



25 High Road, Bethania QLD 4205

MELBOURNE



+61 3 8375 1638



37 Sunline Drive, Truganina VIC 3029

FOLLOW US ON



exhibit[®]
systems ●●●●

Carpeting & Raised Floors & Furniture Packages	4
Furniture - Settings	6
Furniture - Lounges	9
Furniture - Stools & Chairs	11
Furniture - Ottomans & Benches	14
Furniture - Tables	15
Furniture - Counters	18
Counter & Table Graphics	20
Furniture - Brochure Holders	21
Furniture - Display Pods, Slatwall & Pegboard	22
Furniture - Display Panels & Plinths	23
Furniture - Business Accessories	24
Furniture - Outdoor Accessories & Barriers	25
Furniture - Hospitality	26
Furniture - Fashion Displays	27
Furniture - Glass Displays	28
Audio / Visual	32
Sign Frames	34
Faux Pot Plants & Foliage	35
Terms & Conditions	36



For a truly unique and visually striking effect, custom designed stands offer unparalleled freedom of design for your company's exhibit.

Designed to suit any budget, these displays create a unique atmosphere to help you define your corporate identity and enhance your position in the marketplace.





With the low-cost flexibility of Octanorm and Maxima, Exhibit Systems can create dynamic display stands for purchase or hire that will maximise your marketing potential.

Graphic panels, banners, light boxes and benches can all be seamlessly integrated depending on your exhibition objectives and budget.





Creative design and show branding creates an immediate visual impact and visitor interest. Versatility in design allows for functionality and ease of use for delegates and registration staff alike.

Exhibit Systems can create exciting entrance features and innovative registration areas for your exhibition.



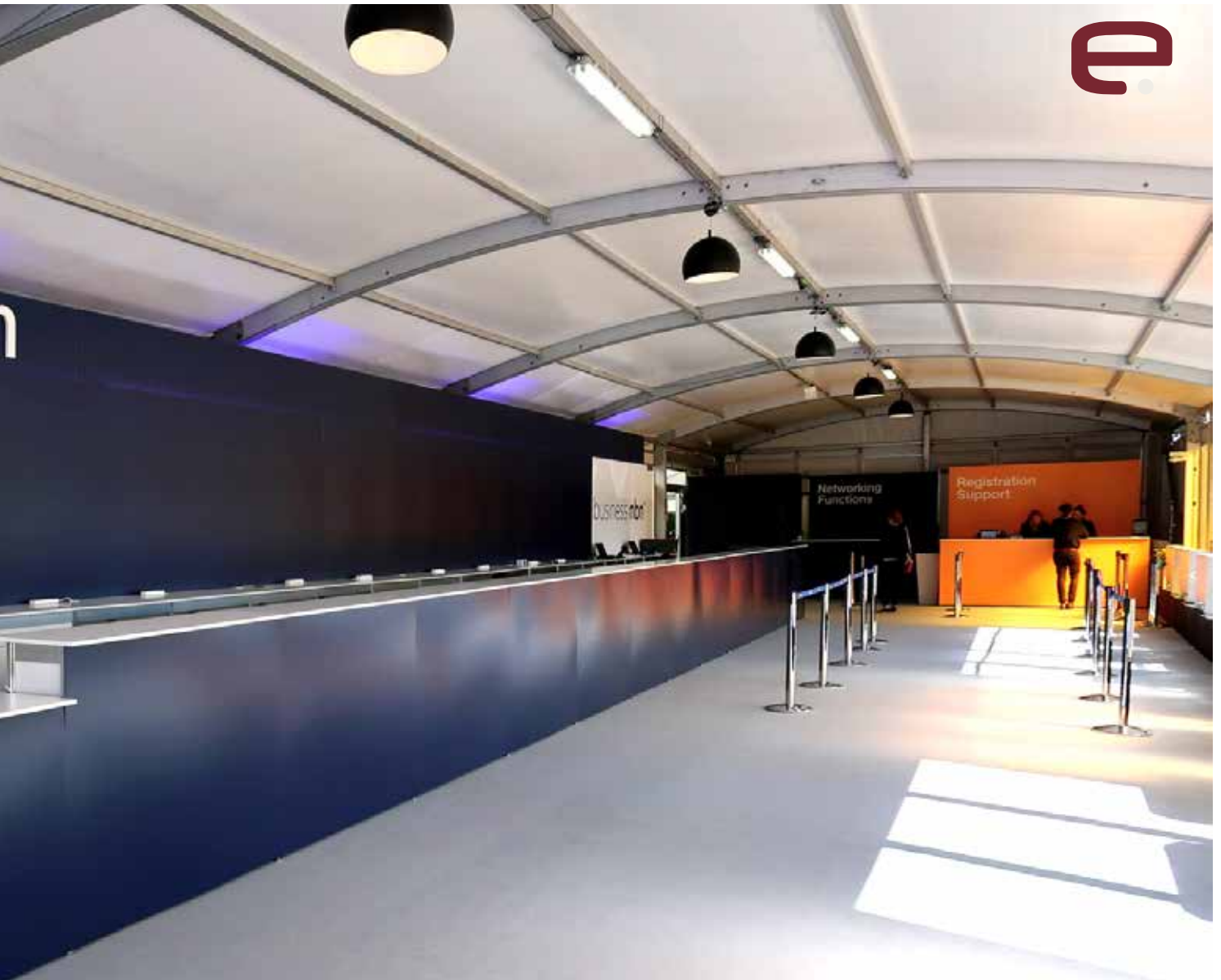

Feature areas can be developed to suit any requirement within an event.

Information booths, internet cafés, meeting areas, lounges and product displays can be designed to complement the overall show branding, adding value to your event with benefits for both exhibitors and attendees.





Creative design and strong show branding maximises visual impact and visitor interest.

Enhance your corporate image using the latest graphics techniques and signage technology to ensure your message is delivered with impact.





Exhibit Systems offers an extensive range of modular components with many different colour combinations available for walls and fascia panels.

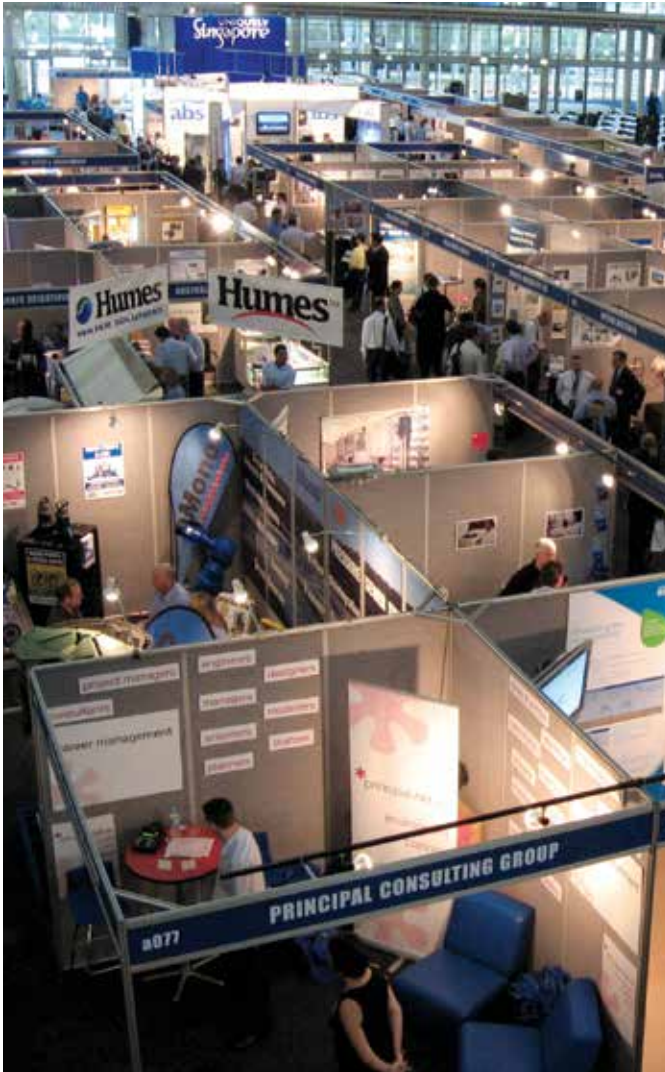



Exhibit Systems offers an extensive hire stock range of modular components to construct hundreds of exhibition booths of any size. All systems are easy to install, flexible and of the highest quality, which means exhibitors receive the best product available, with a trouble free set-up and dismantle.

CORINTHIAN

Velcro-compatible wall panel system with a flush seamless appearance.

WALL COLOURS



FASCIA COLOURS

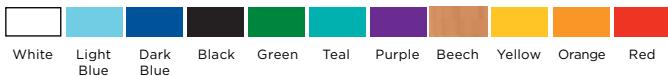

OCTANORM

A highly versatile system with clean lines and a modern appearance. The modular components allow the booths to be easily modified and enhanced for individual exhibit requirements.

Wall panels available include primarily white melamine and grey frontrunner. Other vinyl panel colours are also available.

WALL COLOURS



FASCIA COLOURS

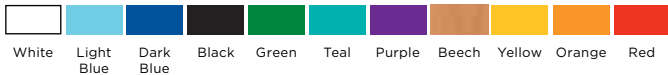

MARCO

A cost effective design solution offering modern streamlined architecture allowing multiple applications such as: creating custom stands, feature areas, theatres and meeting rooms.



With innovative design and attention to detail we can develop creative solutions to enhance the look of any event. The booths can be tailor-made to suit any requirement, offering a more intimate, personal and professional environment for exhibiting.

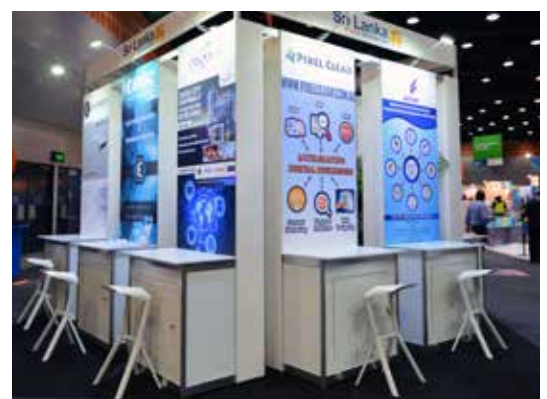

For a truly unique and visually striking effect, upgrade packages offer unparalleled freedom of design for your company's exhibit. Designed to suit any budget, these displays create a unique atmosphere to help you define your corporate identity and enhance your position in the marketplace.

Our upgrade packages are designed to make you stand out from your competitors. With a range of options to suit your booth orientation and your budget, all you have to do is load your AV content and you're good to go!

Detailed specifications for each booth design can be obtained from our Sales Department.

UPGRADE PACKAGES

Upgrade Packages are uniquely customisable. We can adjust, add and create new features for any of your needs. Work with our creative designers and friendly staff to create the exhibition stand of your dreams.



MARCO UPGRADE PACKAGE



MAXIMA UPGRADE PACKAGE



MARCO UPGRADE PACKAGE



OCTANORM UPGRADE PACKAGE



MALABAR

\$8575 ~ \$9500^{+GST}

Maxima Upgrade Package

- Corner & Inline variations
- Carpet & Raised flooring options available



TAMARAMA

\$9850 ~ \$12,520^{+GST}

Maxima Upgrade Package

- Corner & Inline variations
- Carpet & Raised flooring options available

3x3 BOOTHS



CONGWONG

\$11750 ~ \$13820^{+GST}

Maxima Upgrade Package

- Corner & Inline variations
- Carpet & Raised flooring options available



CLOVELLY

\$12930 ~ \$16030^{+GST}

Maxima Upgrade Package

- Corner & Inline variations
- Carpet & Raised flooring options available

6x3 BOOTHS



FRESHMANS

\$16215 ~ \$19620^{+GST}

Maxima Upgrade Package

- Island & Peninsula variations
- Carpet & Raised flooring options available



MAROUBRA

\$17170 ~ \$19700^{+GST}

Maxima Upgrade Package

- Only available in Peninsula
- Carpet & Raised flooring options available

6x6 BOOTHS

3X3 BOOTHS



AVALON \$7034 ~ \$8040 +GST

Marco Upgrade Package

- Corner & Inline variations
- Carpet & Raised flooring options available



FRESHWATER \$7545 ~ \$8590 +GST

Marco Upgrade Package

- Corner & Inline variations
- Carpet & Raised flooring options available

6X3 BOOTHS



COLLAROY \$12000 ~ \$14855 +GST

Marco Upgrade Package

- Corner, Inline & Peninsula variations
- Carpet & Raised flooring options available



MANLY \$11635 ~ \$13610 +GST

Marco Upgrade Package

- Corner, Inline & Peninsula variations
- Carpet & Raised flooring options available

6X5 BOOTHS



BALMORAL \$14076 ~ \$17605 +GST

Marco Upgrade Package

- Island & Peninsula variations
- Carpet & Raised flooring options available
- An overhead banner can be added for an additional fee



CLIFTON \$14076 ~ \$17605 +GST

Marco Upgrade Package

- Island & Peninsula variations
- Carpet & Raised flooring options available
- An overhead banner can be added for an additional fee



NEWPORT

Marco Upgrade Package

- Corner & Inline variations
- Carpet & Raised flooring options available

\$7930 ~ \$8965 +GST



3x3 BOOTHS



SHELLY

Marco Upgrade Package

- Corner, Inline & Peninsula variations
- Carpet & Raised flooring options available

\$11400 ~ \$16100 +GST



6x3 BOOTHS

Marco Upgrade Package



CLONTARF

Marco Upgrade Package

- Island & Peninsula variations
- Carpet & Raised flooring options available

\$15040 ~ \$17480 +GST



DOBROYD

Marco Upgrade Package

- Island & Peninsula variations
- Carpet & Raised flooring options available

\$14068 ~ \$16401 +GST

6x6 BOOTHS

3X3 BOOTHS



BELLAMY \$8540 ~ \$9950^{+GST}

Octanorm Upgrade Package

- Corner & Inline variations
- Carpet & Raised flooring options available



GIBSONS \$5950 ~ \$8040^{+GST}

Octanorm Upgrade Package

- Corner & Inline variations
- Carpet & Raised flooring options available

6X3 BOOTHS



BONDI \$9735 ~ \$11900^{+GST}

Octanorm Upgrade Package

- Corner, Inline & Peninsula variations
- Carpet & Raised flooring options available



BRONTE \$7900 ~ \$10450^{+GST}

Octanorm Upgrade Package

- Corner, Inline & Peninsula variations
- Carpet & Raised flooring options available

6X5 BOOTHS



KUTTI \$10050 ~ \$12360^{+GST}

Octanorm Upgrade Package

- Only available in Peninsula
- Carpet & Raised flooring options available



PARSLEY \$10750 ~ \$13200^{+GST}

Octanorm Upgrade Package

- Only available in Peninsula
- Carpet & Raised flooring options available



NIELSON

\$7140 ~ \$8350^{+GST}

Octanorm Upgrade Package

- Corner & Inline variations
- Carpet & Raised flooring options available



QUEENS

\$7034 ~ \$8040^{+GST}

Octanorm Upgrade Package

- Corner & Inline variations
- Carpet & Raised flooring options available

3x3 BOOTHS



COOGEE

\$9360 ~ \$11470^{+GST}

Octanorm Upgrade Package

- Corner, Inline & Peninsula variations
- Carpet & Raised flooring options available



ROSE

\$8600 ~ \$10370^{+GST}

Octanorm Upgrade Package

- Corner, Inline & Peninsula variations
- Carpet & Raised flooring options available

6x3 BOOTHS



WATSONS

\$11050 ~ \$13360^{+GST}

Octanorm Upgrade Package

- Only available in Peninsula
- Carpet & Raised flooring options available



Octanorm Upgrade Package

6x6 BOOTHS

CARPETING & RAISED FLOORS

Exhibit Systems offers a range of flooring solutions - from entire exhibition halls of carpet tiles, to stepped and ramped raised floors for custom stands and feature areas.

We offer 32mm ramped and 115mm stepped raised floors with a wide range of carpet or timber laminate finishes.

CARPET TILES

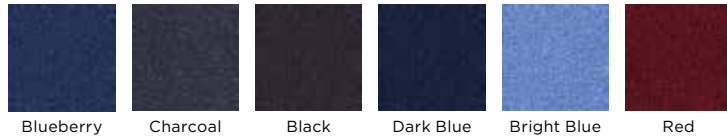

RAISED FLOOR

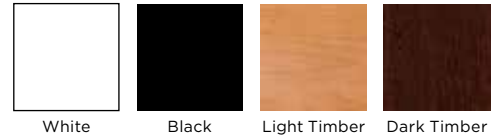

NEEDLE PUNCH CARPET ROLLS

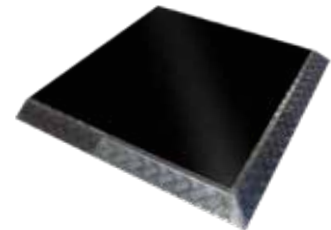

FLOORING

Carpet Tiles

- 1 x 1m carpet tiles

Available Colours

	Black	072002	\$27
	Red	072003	\$27
	Dark Blue	072005	\$22
	Bright Blue	072006	\$22
	Pink	072008	\$33
	Charcoal	072009	\$22
	Blueberry	072010	\$22
	Teal	072012	\$22

FLOORING

Needle Punch Carpet Rolls

- Prices are per square metres & subject to availability.

Available Colours

	Black	\$55
	Red	\$55
	Dark Blue	\$55
	Azure	\$55
	Yellow	\$55
	Green	\$55
	Light Grey	\$55
	Purple	\$55
	Orange	\$55

FLOORING

32mm Raised

- 1 x 1m laminate timber tiles
- 32mm height
- Includes aluminium treadplate
- Ramped edge

Available Colours

	White	071901	\$90
	Black	071902	\$98
	Light	071904	\$103
	Dark	071915	\$125
	Treadplate	071917	\$135

FURNITURE PACKAGES

PACKAGE 1

Walk On Furniture
FP1001

SAVE \$44 **\$396**



• Bella Bar Table x 1



• Tori Stool x 2



• Folding Brochure Rack x 1

PACKAGE 2

Walk On Furniture
FP1002

SAVE \$70 **\$628**

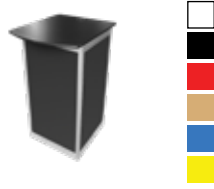

• Octa Computer Module x 1



• Tori Setting x 1



• Folding Brochure Rack x 1

PACKAGE 3

Walk On Furniture
FP1003

SAVE \$77 **\$697**



• Octa Lockable Counter x 1



• Origami Stool Setting x 1



• Folding Brochure Rack x 1

PACKAGE 4

Walk On Furniture
FP1004

SAVE \$80 **\$717**



• Maxima Lockable Counter x 1



• Canton Chair Setting x 1



• Folding Brochure Rack x 1

PACKAGE 5

Walk On Furniture
FP1005

SAVE \$96 **\$868**



• Octa Curved Counter x 1



• Pop Stools x 2



• Linda Setting x 1



• Folding Brochure Rack x 1

PACKAGE 6

Walk On Furniture
FP1006

SAVE \$160 **\$1442**



• Octa Lockable Counter x 1



• Origami Setting x1



• 43" Plasma On Stand



• Folding Brochure Rack x 1

PACKAGE 7

Walk On Furniture
FP1007

SAVE \$198 **\$1782**



• Octa Lockable Counter x 1



• Siena Stool Setting x1



• 43" Plasma On Stand



• Folding Brochure Rack x 1

FURNITURE | STOOL SETTINGS



SAVE \$41

ORIGAMI STOOL SETTING

\$365

Setting

- 1 x White Bella Bar table (1045mm height)
- 3 x Origami Stools – see colour options below

Available Colours

091401 091402 091403 091405
 091409



SAVE \$45

POP STOOL SETTING

\$403

Setting

- 1 x White Bella Bar Table (1045mm height)
- 3 x Pop Stools – see colour options below

Available Colours

091802 091803 091809 091811
 091815



SAVE \$83

SIENA STOOL SETTING

\$743

Setting

- 1 x White Siena Table (1057mm height)
- 4 x Wave Stools

Available Colours

091601



SAVE \$61

TOLIX STOOL SETTING

\$552

Setting

- 1 x Long Tolix Bar Table – Timber option (1070mm height)
- 4 x Tolix Stools – see colour options below

Available Colours

091101 091102 091103 091105
 091108 091111 091301 091107



SAVE \$42

TORI STOOL SETTING

\$376

Setting

- 1 x White Bella Bar table (1045mm height)
- 3 x Tori Stools – see colour options below

Available Colours

091502 091503 091505 091508
 091509



SAVE \$41

VOGUE STOOL SETTING

\$365

Setting

- 1 x White Bella Bar Table (1045mm height)
- 3 x Vogue stools – see colour options below

Available Colours

090701 090702 090703 090705

FURNITURE | CHAIRS & BENCH SETTINGS



SAVE \$36

CANTON CHAIR SETTING

\$326

Setting

- 1 x White Bella table (760mm height)
- 4 x Canton chairs - see colour options below

Available Colours

090101 090102 090103 090105



SAVE \$36

ORIGAMI CHAIR SETTING

\$326

Setting

- 1 x White Bella table (760mm height)
- 4 x Origami Chairs - see colour options below

Available Colours

091411 091412 091413 091415
 091419



SAVE \$41

TOLIX CHAIR SETTING

\$371

Setting

- 1 x Tolix table - Timber option (760mm height)
- 4 x Tolix chairs - see colour options below

Available Colours

091001 091002 091008 091003
 091005 091011



SAVE \$37

TORI CHAIR SETTING

\$337

Setting

- 1 x White Bella table (760mm height)
- 4 x Tori Chairs - see colour options below

Available Colours

091512 091513 091515 091518
 091519



FURNITURE | OTTOMAN & LOUNGE SETTINGS



SAVE
\$41

BRUNO BENCH SETTING

\$373

Setting

- 1 x White TT Coffee Table (900mm x 450mm)
- 2 x Bruno Benches - see colour options below

Available Colours

- 100111 100112 100113 100115
 100119



SAVE
\$49

GEORGE OTTOMAN SETTING

\$445

Setting

- 1 x White TT Coffee table (900mm x 450mm)
- 4 x George Ottomans - see colour options below

Available Colours

- 100101 100102 100103 100105



SAVE
\$39

LINDA LOUNGE SETTING

\$352

Setting

- 1 x White Bella Coffee table (440mm height)
- 2 x Linda Chairs - see colour options below

Available Colours

- 100725 100728 100727 100729



SAVE
\$81

MILAN DOUBLE SETTING

\$727

Setting

- 1 x TT Coffee Table (900mm x 450mm)
- 2 x Double Milan Lounges - see colour options below

Available Colours

- 100601 100602



SAVE
\$55

MILAN SINGLE SETTING

\$499

Setting

- 1 x TT Square Coffee Table (750 x 750mm)
- 2 x Single Milan Lounges - see colour options below

Available Colours

- 100501 100502



SAVE
\$73

ROMA LOUNGE SETTING

\$654

Setting

- 1 x Black Bella Coffee table (440mm height)
- 2 x Roma Chairs

Available Colours

- 100302

FURNITURE | LOUNGE SETS



FELO DOUBLE \$347

Lounge

- Soft cotton upholstery & wooden frame
- A single seater version is available for hire

Available Colours

■ 032120



MILAN DOUBLE \$347

Lounge

- Leather upholstery & chrome frame
- 1560(w) x 800(d) x 800mm(h)

Available Colours

□ 030501 ■ 030502



SOTTI DOUBLE \$287

Lounge

- Sleek cotton upholstery & chrome frame
- A single seater version is available for hire

Available Colours

■ 031039



FELO \$260

Lounge Chair

- Cotton upholstery & wooden frame
- A two-seater version is available

Available Colours

■ 032020



MILAN SINGLE \$220

Lounge Chair

- Leather upholstery & chrome frame
- 800(w) x 730(d) x 700mm(h)

Available Colours

□ 030401 ■ 030402



SOTTI SINGLE \$184

Lounge Chair

- Cotton upholstery & chrome frame

Available Colours

■ 030709



CURVE ENDLESS

Lounge

- High quality vinyl make & chrome frame
- Price is for each individual lounge piece
- 1430(w) x 1220(d) x 690mm(h)

Available Colours

White □ 031801 \$260
 Grey ■ 031809 \$260



FURNITURE | LOUNGES



AVA \$141

Lounge Chair

- Cushioned chair with soft, velvet texture

Available Colours

■ 030815



BARCELONA \$206

Lounge Chair

- Leather upholstery & chrome base
- 750(w) x 800(d) x 700mm(h)

Available Colours

■ 030802 □ 030801



CAPRI TUB \$137

Lounge Chair

- Leather upholstery
- 750(w) x 670(d) x 750mm(h)

Available Colours

■ 031002 ■ 031015



VIDA \$137

Lounge Chair

- Cushioned chair with soft, velvet texture

Available Colours

■ 032222 ■ 032223



LINDA \$141

Lounge Chair

- Cushioned chair with soft, velvet texture

Available Colours

■ 030735 ■ 030737 ■ 030738 ■ 030739

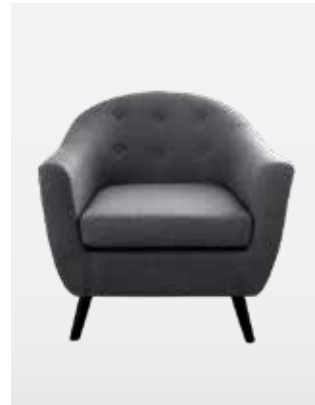

LUXO \$220

Lounge Chair

- Cotton upholstery & matte frame

Available Colours

■ 031905



MELBI \$260

Lounge Chair

- Material upholstery

Available Colours

■ 031520



NOVA \$125

Lounge Chair

- Cotton upholstery & chrome frame

Available Colours

■ 031022 ■ 031023
■ 031025 ■ 031029



ROMA \$309

Lounge Chair

- Velour upholstery
- Chrome Base

Available Colours

■ 030702



SCAV \$137

Lounge Chair

- Cotton upholstery & wooden frame

Available Colours

■ 012020



VERA \$200

Lounge Chair

- Cotton upholstery & chrome frame

Available Colours

■ 031042 ■ 031043
■ 031045 ■ 031049

FURNITURE | STOOLS & CHAIRS



BENJI \$101

Stool

- Modern look stool with sculpted timber seating

Available Colours

020404



BROOKLYN \$114

Stool

- Upholstered cushion seat with back rest and adjustable chrome base

Available Colours

021202

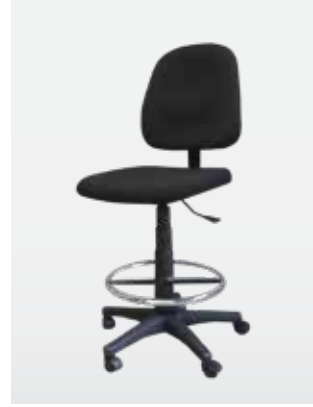

DRAFTING \$95

Stool

- Upholstered seat with backrest
- Adjustable height (600 - 700mm)

Available Colours

020702



FLORIDA \$88

Stool

- Upholstered cushioned seat & chrome base

Available Colours

020102



GHOST \$109

Stool

- Clear plastic stool

Available Colours

021318



MIURA \$104

Stool

- Modern plastic stool

Available Colours

021101 021102



ORIGAMI \$95

Stool

- Sleek plastic stool
- Sturdy chrome frame

Available Colours

020141 020142
 020143 020144
 020145



OVELA \$114

Stool

- Leather upholstery
- Adjustable chrome base

Available Colours

021810



POP \$109

Stool

- Leather upholstery
- Sturdy chrome frame

Available Colours

021122 021123
 021124 021126
 021128



46CM TOLIX \$91

Stool

- Solid steel legs with metal seat

Available Colours

021501 021502
 021503 021505
 021508 021511



66CM TOLIX \$101

Stool

- Powder coated steel legs with wooden seat

Available Colours

021601 021602



66CM TOLIX \$91

Stool

- Solid steel legs with metal seat

Available Colours

021401 021402
 021403 021405
 021407 021408
 021411 021416

FURNITURE | STOOLS & CHAIRS



TORI \$99

Stool

- Cotton upholstery & chrome frame

Available Colours

- 020621
- 020622
- 020623
- 020625
- 020628



TRIESTE \$114

Stool

- Cotton upholstery & chrome frame

Available Colours

- 021709

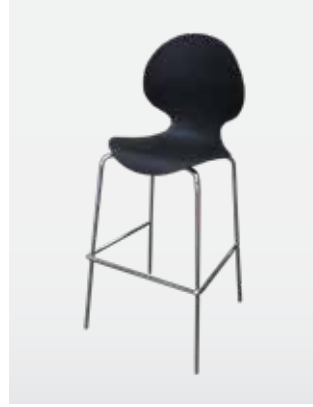

VOGUE \$95

Stool

- Plastic seat with backrest & chrome legs

Available Colours

- 020601
- 020602
- 020603
- 020605



WAVE \$124

Stool

- Wooden stool with sleek design

Available Colours

- 020406



BETIS \$62

Chair

- Plastic seat & aluminium legs/arms

Available Colours

- 010202
- 010209



CANTON \$62

Chair

- Plastic seat & chrome legs

Available Colours

- 010101
- 010102
- 010103
- 010105



EAMES \$109

Chair

- Upholstered seat & gas lift with castors

Available Colours

- 011301
- 011302



EIFFEL \$62

Chair

- Stainless steel base & molded plastic seat

Available Colours

- 011801



FINELINE \$61

Chair

- Upholstered seat & chrome legs

Available Colours

■ 010420

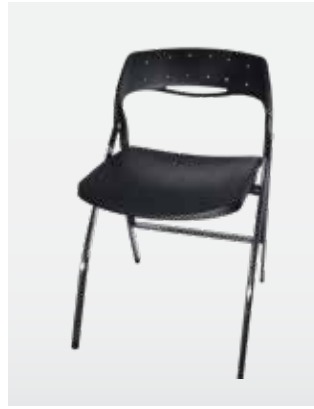

FOLDING \$47

Chair

- Plastic seat & chrome legs

Available Colours

■ 010601 ■ 010602



FRESCO \$61

Chair

- Molded Plastic seat

Available Colours

□ 011901 ■ 011905

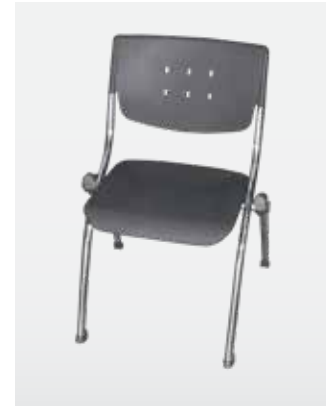

HARVARD \$57

Chair

- Plastic seat & interlocking chrome legs

Available Colours

■ 010309



ORIGAMI \$62

Chair

- Plastic seat & chrome frame

Available Colours

□ 010141 ■ 010142
■ 010143 ■ 010144
■ 010145



STORM \$62

Chair

- Plastic seat & chrome legs

Available Colours

■ 011502 ■ 011503
■ 011505 ■ 011507



TOLIX \$61

Chair

- Powder coated steel

Available Colours

□ 011601 ■ 011602
■ 011603 ■ 011608
■ 011605 ■ 011611



TORI \$65

Chair

- Cotton upholstery & chrome frame

Available Colours

■ 010121 ■ 010122
■ 010123 ■ 010125
■ 010128



TYPIST \$62

Chair

- Cushioned seat, adjustable height & castors

Available Colours

■ 010702



VIENTO \$65

Chair

- Molded plastic

Available Colours

□ 011701



FURNITURE | OTTOMANS & BENCHES



NELSON

Bench

- Strong wooden frame in a stylish black shade
- Comes in two lengths; 1220mm & 1520mm

1220mm **032230** \$163
 1520mm **032231** \$190



BRUNO

Bench

- High quality woven cotton upholstery with a strong chrome base
- 1200mm(w) x 400mm(d) x 450mm(h)

\$150

Available Colours

032241 032242 032243 032245 032249



GEORGE

Ottoman

- Vinyl upholstery with a cushioned seat
- 450(w) x 450(d) x 450mm(h)

\$95

Available Colours

030101 030102 030103 030105 030111



MADRID

Ottoman

- Vinyl upholstery with a cushioned seat
- 450(w) x 450mm(h)

\$95

Available Colours

030301 030302 030303 030311



BEAN BAGS

\$65

Seating

- Black bean bags are Corduroy
- Green are made of vinyl

Available Colours

031302 031303
 031307 031308
 031301 031305



CUSHIONS

\$29

Accessories

- Square cushions (400 x 400mm)

Available Colours

069001 069002
 069003 069005
 069008 069011

FURNITURE | COFFEE TABLES



BELLA COFFEE \$109

Table

- Digital Print (075201) + \$104
- 750(w) x 440mm(h)

Available Colours

- | | | |
|---------------------------------|---------------------------------|---------------------------------|
| <input type="checkbox"/> 040301 | <input type="checkbox"/> 040302 | <input type="checkbox"/> 040303 |
| <input type="checkbox"/> 040304 | <input type="checkbox"/> 040305 | <input type="checkbox"/> 040307 |
| <input type="checkbox"/> 040311 | <input type="checkbox"/> 040308 | |



CROSBY \$60

Table

- Interwoven metal lengths create a sleek modern look

Available Colours

- | | |
|---------------------------------|---------------------------------|
| <input type="checkbox"/> 042221 | <input type="checkbox"/> 042224 |
|---------------------------------|---------------------------------|



HAVANA COFFEE \$118

Table

- 500(w) x 450mm(h)

Available Colours

- | |
|---------------------------------|
| <input type="checkbox"/> 042802 |
|---------------------------------|



MILA COFFEE \$126

Table

- 400(w) x 475mm(h)

Available Colours

- | |
|---------------------------------|
| <input type="checkbox"/> 042204 |
|---------------------------------|



TT COFFEE \$114

Table

- Digital Print (075301) + \$75
- 900(w) x 450(d) x 430mm(h)

Available Colours

- | | | |
|---------------------------------|---------------------------------|---------------------------------|
| <input type="checkbox"/> 040601 | <input type="checkbox"/> 040602 | <input type="checkbox"/> 040603 |
| <input type="checkbox"/> 040604 | <input type="checkbox"/> 040605 | <input type="checkbox"/> 040615 |



TT SQUARE COFFEE \$114

Table

- Digital Print (075401) + \$104
- 750(w) x 750(d) x 430mm(h)

Available Colours

- | | | |
|---------------------------------|---------------------------------|---------------------------------|
| <input type="checkbox"/> 040701 | <input type="checkbox"/> 040702 | <input type="checkbox"/> 040703 |
| <input type="checkbox"/> 040704 | <input type="checkbox"/> 040705 | <input type="checkbox"/> 040715 |



FURNITURE | TABLES



BELLA \$114

Table

- Digital Print (075001) + \$104
- 750(w) x 760mm(h)

Available Colours

- | | | |
|---------------------------------|---------------------------------|---------------------------------|
| <input type="checkbox"/> 040101 | <input type="checkbox"/> 040102 | <input type="checkbox"/> 040103 |
| <input type="checkbox"/> 040104 | <input type="checkbox"/> 040105 | <input type="checkbox"/> 040107 |
| <input type="checkbox"/> 040108 | <input type="checkbox"/> 040111 | |

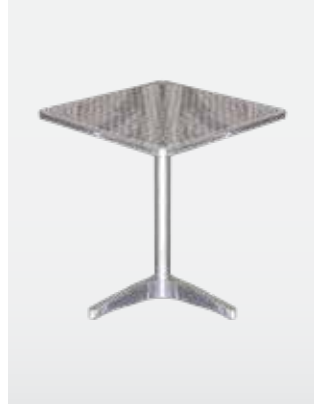

SQUARE CAFE \$95

Table

- 600(w) x 600(d) x 760mm(h)

Available Colours

- | |
|---------------------------------|
| <input type="checkbox"/> 040414 |
|---------------------------------|



TOLIX \$168

Table

- White legs & interchangeable table top
- 700(w) x 700(d) x 750mm(h)

Available Colours

- | | | |
|---------------------------------|---------------------------------|---------------------------------|
| <input type="checkbox"/> 041901 | <input type="checkbox"/> 041902 | <input type="checkbox"/> 041903 |
| <input type="checkbox"/> 041904 | <input type="checkbox"/> 041905 | <input type="checkbox"/> 041908 |
| <input type="checkbox"/> 041911 | | |



LONG TOLIX \$233

Table

- White legs & interchangeable table top
- 795(w) x 1400(d) x 750mm(h)

Available Colours

- | | | |
|---------------------------------|---------------------------------|---------------------------------|
| <input type="checkbox"/> 042601 | <input type="checkbox"/> 042602 | <input type="checkbox"/> 042604 |
|---------------------------------|---------------------------------|---------------------------------|



ELITE TABLES

Table

Elite Meeting 2100(w) x 900(d) x 750mm(h) \$155

- | | | | |
|---------------------------------|---------------------------------|---------------------------------|---------------------------------|
| <input type="checkbox"/> 040901 | <input type="checkbox"/> 040902 | <input type="checkbox"/> 040904 | <input type="checkbox"/> 040915 |
|---------------------------------|---------------------------------|---------------------------------|---------------------------------|

Elite 1500 1500(w) x 750(d) x 750mm(h) \$125

- | | | | | | |
|---------------------------------|---------------------------------|---------------------------------|---------------------------------|---------------------------------|---------------------------------|
| <input type="checkbox"/> 041001 | <input type="checkbox"/> 041002 | <input type="checkbox"/> 041003 | <input type="checkbox"/> 041004 | <input type="checkbox"/> 041005 | <input type="checkbox"/> 041015 |
|---------------------------------|---------------------------------|---------------------------------|---------------------------------|---------------------------------|---------------------------------|

Elite Square 750(w) x 750(d) x 750mm(h) \$101

- | | | | | | |
|---------------------------------|---------------------------------|---------------------------------|---------------------------------|---------------------------------|---------------------------------|
| <input type="checkbox"/> 040801 | <input type="checkbox"/> 040802 | <input type="checkbox"/> 040803 | <input type="checkbox"/> 040804 | <input type="checkbox"/> 040805 | <input type="checkbox"/> 040815 |
|---------------------------------|---------------------------------|---------------------------------|---------------------------------|---------------------------------|---------------------------------|



COVERED TRESTLE \$114

Table

- 1830(w) x 760(d) x 760mm(h)

Available Colours

- | | |
|---------------------------------|---------------------------------|
| <input type="checkbox"/> 041101 | <input type="checkbox"/> 041102 |
|---------------------------------|---------------------------------|

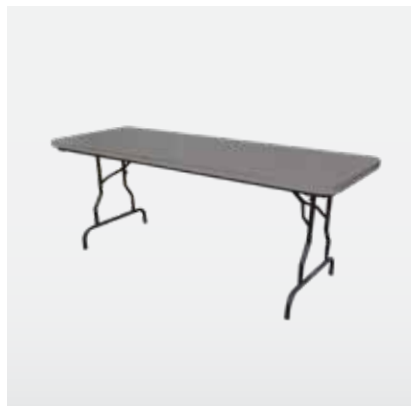

PLASTIC TRESTLE

Table

- 1830(w) x 760(d) x 760mm(h)

041209 \$77

- 1500(w) x 760(d) x 760mm(h)

041109 \$60



TABLE CLOTHS \$39

Accessories

- Two sizes available
- Short, 2200(w) x 1800mm(d)
- Long, 2400(w) x 1800mm(d)

Available Colours

- | | | | |
|---------------------------------|---------------------------------|---------------------------------|---------------------------------|
| <input type="checkbox"/> 061301 | <input type="checkbox"/> 061302 | <input type="checkbox"/> 061303 | <input type="checkbox"/> 061315 |
| <input type="checkbox"/> 061308 | <input type="checkbox"/> 061307 | | |

FURNITURE | BAR TABLES



AMALFI BAR \$230

Table

- Chrome legs & wooden table top
- 1600(w) x 550(d) x 1100mm(h)

Available Colours

- 041701
- 041702
- 041704



AZZURRI BAR \$238

Table

- 1880(w) x 675(d) x 1100mm(h)

Available Colours

- 041801
- 041802
- 041803
- 041804
- 041805



BELLA BAR \$121

Table

- Digital Print (075101) + \$104
- 750(w) x 1045mm(h)

Available Colours

- 040201
- 040202
- 040203
- 040204
- 040205
- 040207
- 040208
- 040211



TOLIX BAR \$173

Table

- White legs & interchangeable table top
- 700(w) x 700(d) x 1070mm(h)

Available Colours

- 042001
- 042002
- 042004
- 042005
- 042003
- 042008
- 042011



LONG TOLIX BAR \$249

Table

- 1500(w) x 600(d) x 1070mm(h)

Available Colours

- 042301
- 042302
- 042304

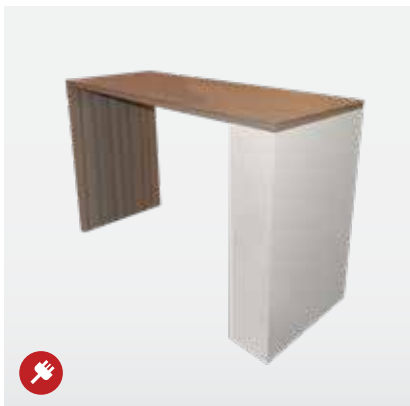

EGGER BAR \$453

Table

- 1500(w) x 500(d) x 1000mm(h)
- Powerpoint connectivity built into tabletop

Available Colours

- 042415



GENIUS BAR \$494

Table

- 2000(w) x 700(d) x 1000mm(h)
- Powerpoint connectivity built into tabletop

Available Colours

- 042021



SIENA BAR \$330

Table

- 1406(w) x 600(d) x 1057mm(h)
- Printed panel for sides available

Available Colours

- 041601

FURNITURE | COUNTERS

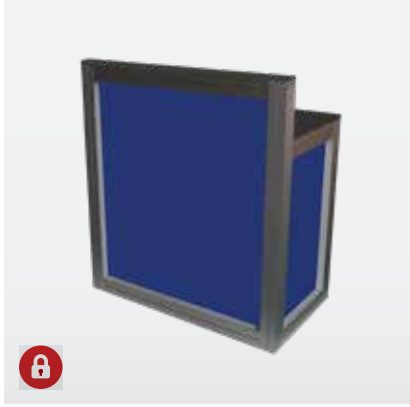

MAXIMA COUNTER \$350
Counter

- 1110(w) x 615(d) x 1200/900mm(h)
- Lockable door

Available Colours

- | | | |
|---------------------------------|---------------------------------|---------------------------------|
| <input type="checkbox"/> 051001 | <input type="checkbox"/> 051002 | <input type="checkbox"/> 051003 |
| <input type="checkbox"/> 051004 | <input type="checkbox"/> 051005 | <input type="checkbox"/> 051007 |



MAXIMA DESK EXT \$407
Counter

- 1850(w) x 615(d) x 1200/900mm(h)
- Lockable door

Available Colours

- | | | |
|---------------------------------|---------------------------------|---------------------------------|
| <input type="checkbox"/> 051101 | <input type="checkbox"/> 051102 | <input type="checkbox"/> 051103 |
| <input type="checkbox"/> 051104 | <input type="checkbox"/> 051105 | <input type="checkbox"/> 051107 |



MAXIMA LOCKABLE \$350
Counter

- 1110(w) x 615(d) x 1000mm(h)
- Lockable door

Available Colours

- | | | |
|---------------------------------|---------------------------------|---------------------------------|
| <input type="checkbox"/> 051601 | <input type="checkbox"/> 051602 | <input type="checkbox"/> 051603 |
| <input type="checkbox"/> 051604 | <input type="checkbox"/> 051605 | <input type="checkbox"/> 051607 |



OCTA CORNER \$315
Counter

- Lockable doors

Available Colours

- | | | |
|---------------------------------|---------------------------------|---------------------------------|
| <input type="checkbox"/> 051301 | <input type="checkbox"/> 051302 | <input type="checkbox"/> 051303 |
| <input type="checkbox"/> 051304 | <input type="checkbox"/> 051305 | <input type="checkbox"/> 051307 |



OCTA CURVED \$273
Counter

- 1440(w) x 730(d) x 1000mm(h)
- Open at back

Available Colours

- | | | |
|---------------------------------|---------------------------------|---------------------------------|
| <input type="checkbox"/> 050801 | <input type="checkbox"/> 050802 | <input type="checkbox"/> 050803 |
| <input type="checkbox"/> 050804 | <input type="checkbox"/> 050805 | <input type="checkbox"/> 050807 |

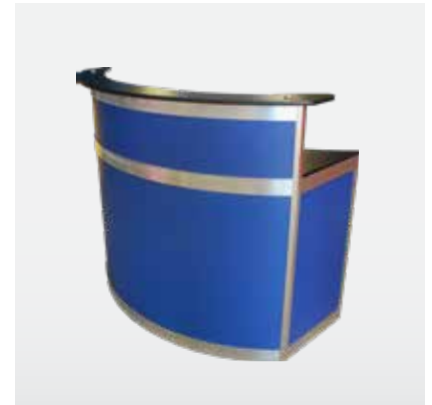

OCTA CURVED RECEPTION \$345
Counter

- 1440(w) x 730(d) x 1200/900mm(h)

Available Colours

- | | | |
|---------------------------------|---------------------------------|---------------------------------|
| <input type="checkbox"/> 050701 | <input type="checkbox"/> 050702 | <input type="checkbox"/> 050703 |
| <input type="checkbox"/> 050704 | <input type="checkbox"/> 050705 | <input type="checkbox"/> 050707 |



OCTA CURVED REVERSED \$273
Counter

- 1440(w) x 730(d) x 1000mm(h)
- Open at back

Available Colours

- | | | |
|---------------------------------|---------------------------------|---------------------------------|
| <input type="checkbox"/> 050901 | <input type="checkbox"/> 050902 | <input type="checkbox"/> 050903 |
| <input type="checkbox"/> 050904 | <input type="checkbox"/> 050905 | <input type="checkbox"/> 050907 |



OCTA DESK \$185
Desk

- 1565(w) x 780(d) x 785mm(h)
- Open at back

Available Colours

- | | | |
|---------------------------------|---------------------------------|---------------------------------|
| <input type="checkbox"/> 050601 | <input type="checkbox"/> 050602 | <input type="checkbox"/> 050603 |
| <input type="checkbox"/> 050604 | <input type="checkbox"/> 050605 | <input type="checkbox"/> 050607 |



OCTA GLASS TOP \$294
Counter

- 1030(w) x 535(d) x 1200mm(h)
- Lockable door & internal shelf

Available Colours

- | | | |
|---------------------------------|---------------------------------|---------------------------------|
| <input type="checkbox"/> 050401 | <input type="checkbox"/> 050402 | <input type="checkbox"/> 050403 |
| <input type="checkbox"/> 050404 | <input type="checkbox"/> 050405 | <input type="checkbox"/> 050407 |



OCTA LOCKABLE \$288

Counter

- 1030(w) x 535(d) x 1000mm(h)
- Lockable door & internal shelf

Available Colours

- | | | |
|---------------------------------|---------------------------------|---------------------------------|
| <input type="checkbox"/> 050201 | <input type="checkbox"/> 050202 | <input type="checkbox"/> 050203 |
| <input type="checkbox"/> 050204 | <input type="checkbox"/> 050205 | <input type="checkbox"/> 050207 |



OCTA LOCKABLE EXT \$330

Counter

- 2020(w) x 535(d) x 1000mm(h)
- Lockable door

Available Colours

- | | | |
|---------------------------------|---------------------------------|---------------------------------|
| <input type="checkbox"/> 051701 | <input type="checkbox"/> 051702 | <input type="checkbox"/> 051703 |
| <input type="checkbox"/> 051704 | <input type="checkbox"/> 051705 | <input type="checkbox"/> 051707 |

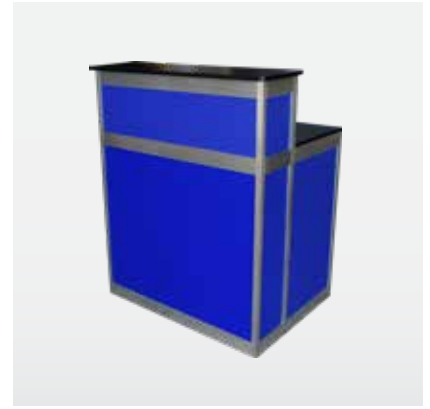

OCTA REGISTRATION \$304

Counter

- 1030(w) x 985(d) x 1200/900mm(h)

Available Colours

- | | | |
|---------------------------------|---------------------------------|---------------------------------|
| <input type="checkbox"/> 050101 | <input type="checkbox"/> 050102 | <input type="checkbox"/> 050103 |
| <input type="checkbox"/> 050104 | <input type="checkbox"/> 050105 | <input type="checkbox"/> 050107 |



OCTA COMPUTER MODULE \$201

Counter

- 565(w) x 700(d) x 1000mm(h)
- Lockable door & internal shelf

Available Colours

- | | |
|---------------------------------|---------------------------------|
| <input type="checkbox"/> 050301 | <input type="checkbox"/> 050302 |
| <input type="checkbox"/> 050303 | <input type="checkbox"/> 050304 |
| <input type="checkbox"/> 050305 | <input type="checkbox"/> 050307 |



BALLOT \$118

Entry Box

- Lockable with entry slot
- Printed Panels / other colours available
- 380(w) x 380(d) x 1000mm(h)

Available Colours

- | | |
|---------------------------------|---------------------------------|
| <input type="checkbox"/> 061501 | <input type="checkbox"/> 061502 |
|---------------------------------|---------------------------------|



PLINTHS

Display

- | | | |
|----------------------------|----------------------------|----------------------------|
| 300mm Plinth \$76 | 600mm Plinth \$95 | 900mm Plinth \$118 |
| 535(w) x 535(d) x 300mm(h) | 535(w) x 535(d) x 600mm(h) | 535(w) x 535(d) x 900mm(h) |

Available Colours

- | | |
|---------------------------------|---------------------------------|
| <input type="checkbox"/> 070201 | <input type="checkbox"/> 070202 |
| <input type="checkbox"/> 070203 | <input type="checkbox"/> 070204 |
| <input type="checkbox"/> 070205 | <input type="checkbox"/> 070207 |

Available Colours

- | | |
|---------------------------------|---------------------------------|
| <input type="checkbox"/> 070301 | <input type="checkbox"/> 070302 |
| <input type="checkbox"/> 070303 | <input type="checkbox"/> 070304 |
| <input type="checkbox"/> 070305 | <input type="checkbox"/> 070307 |

Available Colours

- | | |
|---------------------------------|---------------------------------|
| <input type="checkbox"/> 070401 | <input type="checkbox"/> 070402 |
| <input type="checkbox"/> 070403 | <input type="checkbox"/> 070404 |
| <input type="checkbox"/> 070405 | <input type="checkbox"/> 070407 |



COUNTER & TABLE GRAPHICS



MAXIMA RECEPTION

Graphic

- Print size: 965(w) x 1055mm(h)

Front **076101** **\$194**



MAXIMA DESK EXT

Graphic

- Print size: 965(w) x 1055mm(h)

Front **076201** **\$194**



MAXIMA LOCKABLE

Graphic

- Print size: 965(w) x 855mm(h)

Front **076001** **\$157**



OCTA CURVED

Graphic

- Print size: 1527(w) x 880mm(h)

Front **077401** **\$256**



OCTA CURVED RECEPTION

Graphic

- Top print size: 1527(w) x 250mm(h)
- Base print size: 1527(w) x 780mm(h)

Top **077602** **\$73**
Base **077601** **\$227**

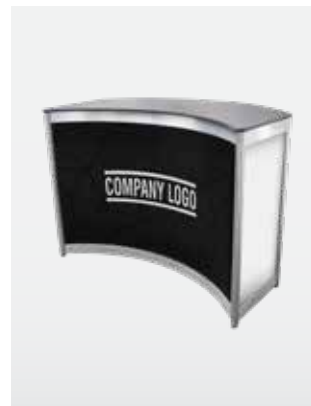

OCTA CURVED REVERSED

Graphic

- Print size: 1527(w) x 880mm(h)

Front **077901** **\$249**



OCTA GLASS TOP

Graphic

- Print size: 965(w) x 780mm(h)

Front **077301** **\$143**

COST IS FOR GRAPHICS ONLY. FURNITURE TO BE ORDERED SEPARATELY.



OCTA LOCKABLE

Graphic

- Print size: 965(w) x 880mm(h)

Front **077001** **\$162**



OCTA LOCKABLE EXT

Graphic

- Print size: 965(w) x 880mm(h)

Front **077101** **\$162**



OCTA REGISTRATION

Graphic

- Top print size: 965(w) x 250mm(h)
- Base print size: 965(w) x 780mm(h)

Top **077202** **\$44**
Base **077201** **\$139**



OCTA COMPUTER MODULE

Graphic

- Print size: 470(w) x 880mm(h)

Front **077801** **\$79**



BALLOT BOX

Graphic

- Print size: 330(w) x 880mm(h)

Front **079001** **\$77**



PLINTHS

Graphic

300mm Plinth	Print size: 470(w) x 180mm(h)	079101	\$26
600mm Plinth	Print size: 470(w) x 480mm(h)	079102	\$52
900mm Plinth	Print size: 470(w) x 780mm(h)	079103	\$77



TT TABLES

Graphic

- Laminated to table top

TT Coffee Table	Print size: 900(w) x 450mm(d)	075301	\$77
TT Square Table	Print size: 750(w) x 750mm(d)	075401	\$107



BELLA TABLES

Graphic

- Laminated to table top

Bella Table	Print size: 750mm(d)	075001	\$107
Bella Bar Table	Print size: 750mm(d)	075101	
Bella Coffee Table	Print size: 750mm(d)	075201	

COST IS FOR GRAPHICS ONLY. FURNITURE TO BE ORDERED SEPARATELY.

Hire rates do not include Cartage, Damage Waiver or GST, and are for the duration of the exhibition.

FURNITURE | BROCHURE HOLDERS



A4 ACRYLIC HOLDER \$26
Brochure Holder

Wall Mount **060601**

Desk Mount **062001**



A4 ACRYLIC HOLDER \$43
Brochure Holder

- Present brochures in a staggered layout

Desk Mount **067116**



RAMPED \$124
Brochure Holder

- 290(w) x 290(d) x 1200mm(h)
- Black frame/mesh & Coloured infills

Available Colours

072501 **072502** **072503**
 072505

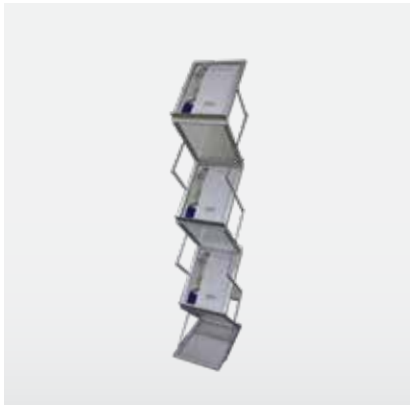

FOLDING \$121
Brochure Holder

- A4 brochure holder
- Double-sided
- 1430mm height with 6 shelves

Item Code **060808**



ZIG-ZAG \$124
Brochure Holder

- A4 brochure holder
- Double-sided

1430mm (h) w/6 Shelves **060701** \$124
1665mm (h) w/5 Shelves **060702** \$124



MODE SHELF UNIT \$184
Brochure Holder

- 5 Shelves available as flat or at 45 degrees

Available Colours

067901 **067902** **067903**
 067904 **067905** **067907**
 067911



FURNITURE | DISPLAY PODS



OCTA DEMO \$1008

Pod - Includes digital print sign panel

- 1030(w) x 660(d) x 2440mm(h)
- Graphic: 1030mm (w) x 250mm (h)
- Audio-visual ordered separately

Available Colours

- 051401 051402 051403
- 051405



OCTA CURVED DEMO \$916

Pod - Includes digital print sign panel

- 1030(w) x 800(d) x 2440mm(h)
- Graphic: 1078mm (w) x 300mm (h)
- Audio-visual ordered separately

Available Colours

- 051801 051802 051803
- 051805



OCTA INFO \$410

Pod - Includes digital print sign panel

- 1440(w) x 670(d) x 2440mm(h)
- Graphic: 1532mm (w) x 240mm (h)
- Open at back

Available Colours

- 051901 051902 051903
- 051905



OCTA DOUBLE \$530

Pod - Includes digital print sign panel

- 565 (w) x 1330(d) x 2000mm(h)
- Graphic: 470mm (w) x 864mm (h)
- Double-sided with lockable doors
- Audio-visual ordered separately

Available Colours

- 052001 052002 052003
- 052005

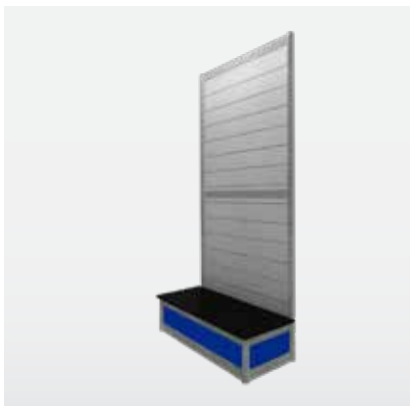

OCTA SLATWALL \$227

Pod

- 1030(w) x 410(d) x 2440mm(h)
- Slatwall fittings ordered separately

Available Colours

- 064701 064702 064703
- 064705



1) CLOTHES RAIL



3) HANGER



2) ACRYLIC SHELF



4) PEG



5) WATERFALL

SLATWALL

Fittings

- Display fittings for slat wall pods or slat wall panels

1) Clothes Rail	071416	\$31	4) Peg	071516	\$8
2) Acrylic Shelf	071201	\$31	5) Waterfall	071016	\$21
3) Hanger	071316	\$11			

FURNITURE | DISPLAY PANELS & PLINTHS

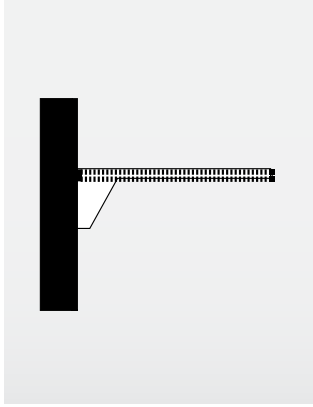

FLAT WALL

Shelving

- 1030(w) x 300mm(d) x Approx. 15mm(h)
- Aluminium front lip
- Fits onto corinthian structure

Set of 3 **072116** **\$178**
Extra Shelf **072119** **\$60**

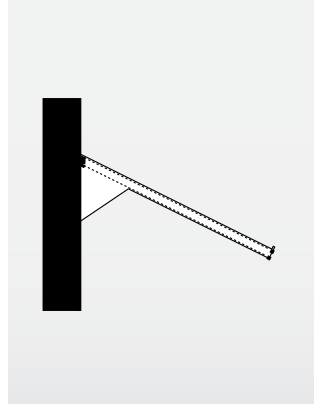

ANGLED WALL

Shelving

- 1030(w) x 300mm(d) x Approx. 15mm(h)
- Aluminium front lip
- Fits onto corinthian structure

Set of 3 **072117** **\$178**
Extra Shelf **072118** **\$60**

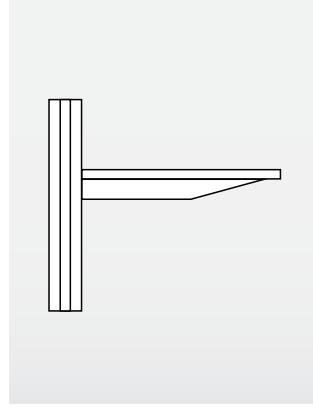

FLAT OCTA

Shelving

- 1030(w) x 300mm(d)
- Fits onto octanorm structure

Set of 3 **072201** **\$178**
Extra Shelf **072203** **\$60**

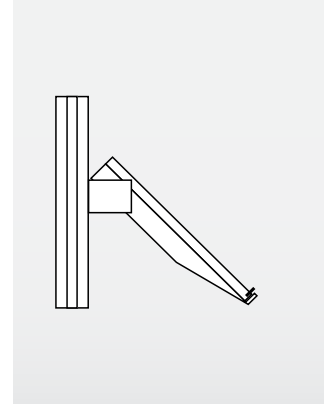

ANGLED OCTA

Shelving

- 1030(w) x 300mm(d)
- Adjustable angle
- Fits onto octanorm structure

Set of 3 **072202** **\$178**
Extra Shelf **072200** **\$60**



SMALL LOGO

\$79

Shelving

- 600(w) x 300(d) x 510mm(h)
- Glass Shelves

Item Code **072602**



MEDIUM LOGO

\$111

Shelving

- 600(w) x 300(d) x 900mm(h)
- Glass Shelves

Item Code **072702**



LARGE LOGO

\$147

Shelving

- 600(w) x 300(d) x 1290mm(h)
- Glass Shelves

Item Code **072802**



HORIZONTAL

\$101

Panel

- Freestanding or linked
- Velcro-compatible
- 2000(h)/2440(h) x 2400mm(w)

Available Colours

070802 **070809**



VERTICAL

\$101

Panel

- Freestanding or linked
- Velcro-compatible
- 940(w) x 2400mm(h)/2000mm(h)

Available Colours

070902 **070909**



CORINTHIAN

\$101

Panel

- Freestanding or linked
- Velcro-compatible
- 1000(w) x 2400mm(h)

Available Colours

072302 **072305**

FURNITURE | BUSINESS ACCESSORIES



EASEL \$63

Display

- Display easel
- Adjustable height

Item Code ■ 062104



WHITE BOARD

Single Item

- 1200(w) x 900mm(h)
- Wall-mountable
- Can be used with easel (ordered separately)

Board **064401** **\$102**
Pens **064503** **\$21**



WHITE BOARD

Freestanding

- 700(w) x 1000mm(h)
- 960(w) x 1780mm(h)

Board **064501** **\$102**
Pens **064503** **\$21**



WHITE BOARD

Freestanding

- 1200(w) x 900mm(h)
- 1300(w) x 1750mm(h)

Board **065201** **\$121**
Pens **064503** **\$21**



CHART

Freestanding

- 700(w) x 1000mm(h)
- 960(w) x 1780mm(h)

Chart **064501** **\$102**
Pens **064503** **\$21**
Paper **064502** **\$79**



BARREL

\$209

Mobile Entry Barrel

- Rotating barrel
- Lockable door hatch
- White frame with castors
- 700(w) x 430(d) x 1100mm(h)

Item Code □ 062501



BOWL \$64

Glass Bowl

- Clear, transparent glass bowl
- Perfect for business cards

Item Code □ 061901



FURNITURE | OUTDOOR ACCESSORIES & BARRIERS



BETIS SETTING

\$309

Setting

- 1 x Square Cafe table (760mm height)
- 4 x Betis chairs

Available Colours

■ 090302 ■ 090309



MIMOSA LOUNGE

\$260

Seating

- Woven plastic base
- 1320(w) x 660(d) x 640mm(h)

Available Colours

■ 031715

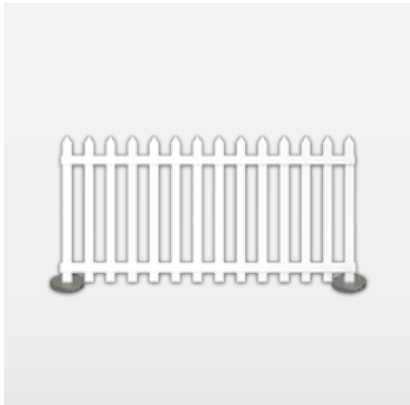

PICKET FENCE

\$130

Outdoor Accessory

- Sturdy painted wooden fencing for a whimsical outdoor look
- Each fence is hired in 1.8m sections

Item Code

□ 062318



JASPER UMBRELLA

\$85

Outside Umbrella

- Wind-up crank to open and close canopy
- 50+| UPF protection rating
- Secures into a table or base

Item Code

■ 067520



MARQUEE UMBRELLA

\$85

Outside Umbrella

- Crank handle to open and close canopy
- 50+| UPF protection rating
- Lightweight aluminium and steel frame

Item Code

■ 067620



ROPE

\$38

Barrier

- 1500mm rope length
- Chrome Post not included

Available Colours

■ 061403 ■ 061402



CHROME POST/A4 HOLDER

Post / Holder

- Items compatible with one another
- Chrome Post and A4 Holder to be ordered separately

A4 Holder Only **062301 \$35**
Chrome Post Only **061416 \$31**



TENSA & POST

\$69

Barrier

- Chrome post retractable belt
- 1500mm length
- 2 sets minimum required

Available Colours

■ 062316 ■ 062312



OCTA

\$124

Barrier

- Digital Print Front (078901) + \$254
- 785(h) x 2000mm span (approx)
- Can link to form fence

Available Colours

□ 072401 ■ 072402
■ 072403 ■ 072405

FURNITURE | HOSPITALITY



BAR \$151

Fridge

- Bar fridge with mini freezer
- 500(w) x 555(d) x 850mm(h)

Item Code ■ 060101



GLASS DISPLAY \$265

Fridge

- Glass door display fridge
- Internal light
- 2x adjustable shelves
- 500(w) x 560(d) x 755mm(h)

Item Code ■ 062601



STAINLESS STEEL \$545

Fridge

- Full-height fridge
- Glass front door
- 700(w) x 600(d) x 1950mm(h)

Item Code ■ 066708



WHITE FRIDGE \$304

Fridge & Freezer

- Full-height fridge
- Separate freezer at bottom
- 600(w) x 600(d) x 1715mm(h)

Item Code ■ 060201



WATER COOLER

Cooler

- Water cooler
- 300(w) x 300(d) x 1000mm(h)
- Water bottles and cups ordered separately

Cooler	064101	\$166
Bottles	064201	\$22
Cups (50 qty)	064301	\$21



WATER URN \$76

Hot Water - 8 Litre

- Electric hot water urn
- 8 litre capacity

Item Code ■ 064001



WASTE BASKET \$21

Small Bin

- Plastic waste basket at 350mm(h)

Item Code ■ 060502



PUSH LID \$43

Bin

- Stainless steel
- Push lid top
- 545mm height

Item Code ■ 060516

FURNITURE | FASHION DISPLAYS



ANGLED \$95

Hanger

- Chrome 4-way clothes hanger
- Height adjustable arms

Item Code ■ 060316



LEVEL \$95

Hanger

- Chrome 4-way clothes hanger
- Height adjustable arms

Item Code ■ 060416



MOBILE \$95

Hanger

- Portable clothes hanger
- On castors
- Adjustable height

Item Code ■ 064816



COAT \$77

Stand

- 1745(h) x 330mm(d)
- 6 x hangers

Item Code ■ 063316



CHEVAL \$101

Mirror

- 370(w) x 490(d) x 1435mm(h)
- Silver frame

Item Code ■ 063208



FURNITURE | GLASS DISPLAYS

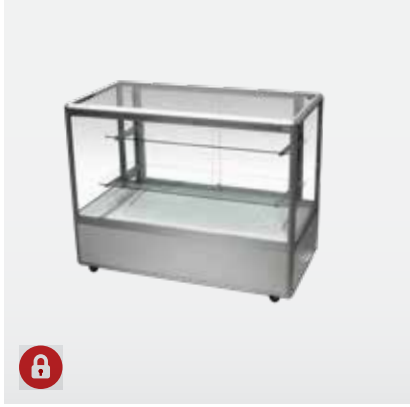

3/4 GLASS

\$350

Showcase

- 1200(w) x 600(d) x 900mm(h)
- Lockable glass top section
- Lockable base cupboard

Item Code

■ **070109**

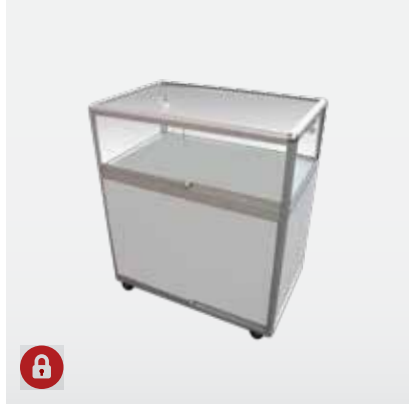

DEVINO

\$350

Showcase

- measurements on request
- Lockable glass top section
- Lockable base cupboard

Item Code

■ **070101**

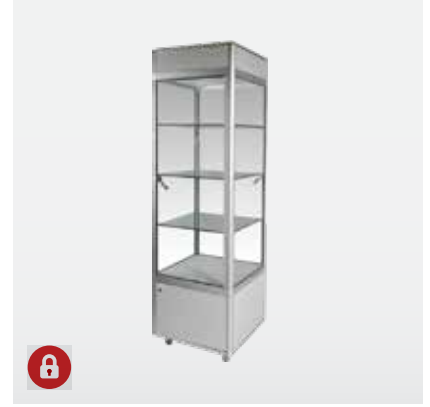

GLASS TOWER

\$410

Showcase

- 600(w) x 600(d) x 1800mm(h)
- Lockable glass top section
- Lockable base cupboard
- Lights in top section

Item Code

■ **070102**

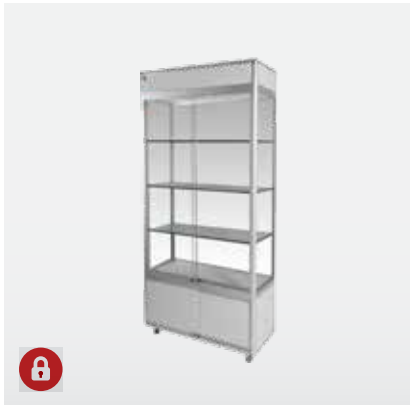

GLASS WINDOW

\$500

Showcase

- 1000(w) x 450(d) x 1800mm(h)
- Lockable glass top section
- Lockable base cupboard

Item Code

■ **070105**

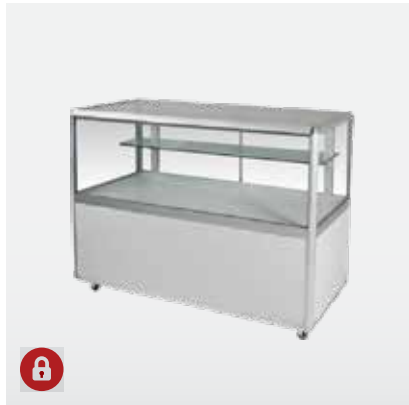

HALF GLASS

\$350

Showcase

- 1200(w) x 600(d) x 950mm(h)
- Lockable glass top section
- Lockable base cupboard
- With light

Item Code

■ **070107**

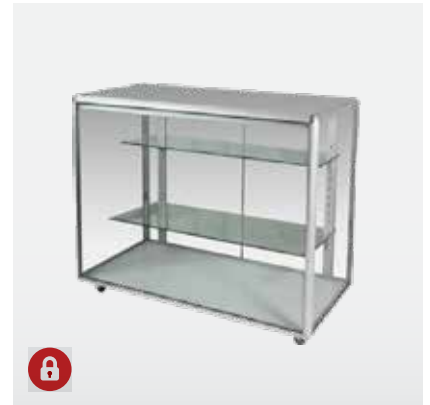

FULL GLASS

\$380

Showcase

- 1200(w) x 600(d) x 950mm(h)
- Lockable glass top section
- With light

Item Code

■ **070108**



AUDIO / VISUAL | SCREENS & STANDS



82" LCD FULL HD

TV Screen

- Desk mounted (comes standard)
- Wall-mount or Plasma stand (order separately)

1-2 days	084801	
3 days	084802	
4-7 days	084803	

\$2594
\$3134
\$3760



65" LCD FULL HD

TV Screen

- Desk mounted (comes standard)
- Wall-mount or Plasma stand (order separately)

1-2 days	084301	
3 days	084302	
4-7 days	084303	

\$1068
\$1353
\$1675



55" LCD FULL HD

TV Screen

- Desk mounted (comes standard)
- Wall-mount or Plasma stand (order separately)

1-2 days	081701	\$925
3 days	081702	\$1238
4-7 days	081703	\$1583



43" LCD FULL HD

TV Screen

- Desk mounted (comes standard)
- Wall-mount or Plasma stand (order separately)

1-2 days	081611	\$714
3 days	081612	\$928
4-7 days	081613	\$1104



40" LCD FULL HD

TV Screen

- Desk mounted (comes standard)
- Wall-mount or Plasma stand (order separately)

1-2 days	081601	\$668
3 days	081602	\$871
4-7 days	081603	\$1038

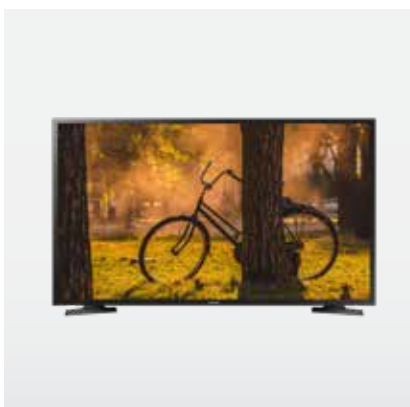

32" LCD FULL HD

TV Screen

- Desk mounted (comes standard)
- Wall-mount or Plasma stand (order separately)

1-2 days	080601	\$619
3 days	080602	\$747
4-7 days	080603	\$871



26" LCD FULL HD

TV Screen

- Desk mounted (comes standard)
- Wall-mount or Plasma stand (order separately)

1-2 days	082701	\$404
3 days	082702	\$471
4-7 days	082703	\$527

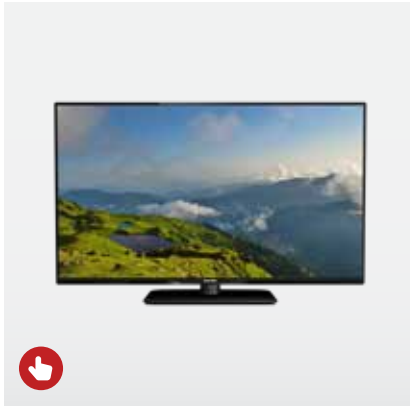

40" TOUCHSCREEN

TV Touchscreen

- Desk mounted (comes standard)
- Wall-mount or Plasma stand (order separately)

1-2 days	084701	\$941
3 days	084702	\$1060
4-7 days	084703	\$1190

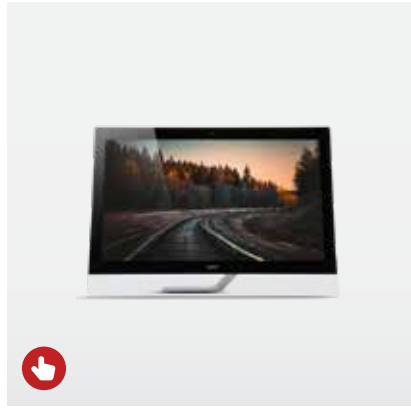

27" TOUCHSCREEN

TV Touchscreen

- Desk mounted (comes standard)
- Wall-mount or Plasma stand (order separately)

1-2 days	084704	\$643
3 days	084705	\$756
4-7 days	084706	\$846



15.6" PC LAPTOP

Laptop

- Uses Windows operating system

1-2 days	083101	\$234
3 days	083102	\$328
4-7 days	083103	\$407



LILLIPAD FLOOR STAND

iPad Holder

- iPad Floor Stand (iPad not included - order iPad separately)

1-2 days	083501	\$156
3 days	083502	\$203
4-7 days	083503	\$240



LILLIPAD DESK STAND

iPad Holder

- iPad Desk Stand (iPad not included - order iPad separately)

1-2 days	083401	\$156
3 days	083402	\$203
4-7 days	083403	\$240



PROJECTOR

Digital

- 3000 lumens of brightness
- Connects to your computer

1-2 days	084501	\$390
3 days	084502	\$570
4-7 days	084503	\$790



WALL MOUNT PULL DOWN

Pull Down Screen

- Screen size approx 2.0m x 2.4m

1-2 days	083201	\$117
3 days	083202	\$132
4-7 days	083203	\$142



KEYBOARD & MOUSE \$50

Peripheral

- Plugs into your computer through a USB and Plug & Play software.

Item Code **082201**



43" SCREEN & STAND

Screen & Stand

- Includes 43" LCD screen
- Includes shelf
- Landscape or portrait display

1-2 days	082101	\$828
3 days	082102	\$1038
4-7 days	082103	\$1188



55" SCREEN & STAND

Screen & Stand

- Includes 55" LCD screen
- Includes shelf
- Landscape or portrait display

1-2 days	082121	\$1015
3 days	082122	\$1347
4-7 days	082123	\$1671



SOUND BAR

Audio

- Bluetooth and 3.5mm audio jack connectivity
- Can be both USB-powered or wirelessly charged (6hr battery life)

1-2 days	081020	\$76
3 days	081021	\$87
4-7 days	081022	\$98

AUDIO / VISUAL | LIGHTING / ELECTRICAL | STAGING



BLU-RAY

Player

- High-definition Blu-Ray player

1-2 days	081501	\$122
3 days	081502	\$132
4-7 days	081503	\$144



HDMI - 2 WAY

Splitter

- 2-way HDMI splitter
- Run up to 2 screens

1-2 days	083001	\$114
3 days	083002	\$138
4-7 days	083003	\$167



HDMI - 4 WAY

Splitter

- 4-way HDMI splitter
- Run up to 4 screens

1-2 days	082901	\$127
3 days	082902	\$149
4-7 days	082903	\$178



EXTENSION CORD

POA

Power

- Power supply to a 10 amp powerpoint

Item Code ■ **009011**



4 WAY BOARD

\$33

Power

- Multi-outlet power board

Item Code ■ **009009**



SWITCHBOARD

Power

- Various switchboards

3-phase distribution switchboard	■ 009002	\$258
20 amp 3-phase	■ 009005	\$464
32 amp 3-phase	■ 009006	\$721



POWER SUPPLY

Power

10amp	009001	\$149
15amp	009053	\$196
20amp	009003	\$263





32w ON-ARM **\$144**

LED On-Arm Light

- 32w arm light

Item Code ■ **009035**



48w ON-ARM **\$160**

LED On-Arm Light

- 48w arm light

Item Code ■ **009038**

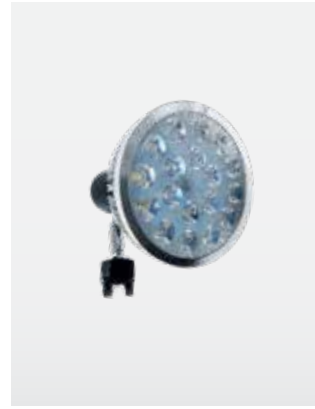

28w SPOTLIGHT **\$134**

LED Track Spotlight

- LED track spotlight

Item Code ■ **009023**



PAR CAN **POA**

Spotlight

- 64w LED PAR CAN

Item Code ■ **E216**



LED STRIP **POA**

Custom Lighting

- Adhesive LED strip
- Can display a variety of colours

Item Code ■ **E218**



STORM LAMP **\$93**

Floor Lamp

Item Code □ **068101**

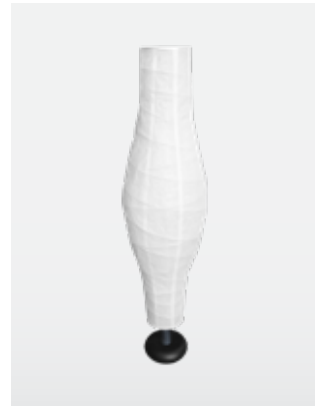

DUDERO **\$93**

Floor Lamp

Item Code □ **068201**



SAMTID **\$103**

Floor Lamp

Item Code □ **068301**



STAGE

1m x 1m

- 1000 x 1000mm
- With black edge trim
- Carpet ordered separately

300mm(h) **071601** **\$78**
600mm(h) **071602** **\$101**



STAGE

2m x 1m

- 2000 x 1000mm
- With black edge trim

300mm(h) **071701** **\$104**
600mm(h) **071702** **\$114**
900mm(h) **071703** **\$126**



STAGE

Steps

- 1000(w) x 430(d) x 400(h)mm
- For 600mm height stage units
- Black painted finish

Steps **071802** **\$78**

SIGN FRAMES



REFRAME LIGHTBOX

Lightbox

- 1000mm(w) x 2000mm(h)
- Double-side print
- Purchase item
- Other sizes available - price on application

Reframe Lightbox **063301** **\$1700**



A-FRAME

Sign Holder

- Insert size: 600(w) x 900mm(h)
- Single-sided or double-sided

Sign Holder Only **065001** **\$108**
Single Print **078101** **\$105**



OCTA TILTED

Sign Holder

- Panel size: 675(w) x 1500mm(h)
- Single-sided only

Sign Holder Only **063001** **\$126**
Single Print **078201** **\$187**



M-BOARD

Sign Holder

- 10mm Foamcore sign into M-Board Base
- Price is for single sided print. Price for double sided print available upon request.

600mm x 1850mm **067809** **\$341**
1000mm x 2000mm **067909** **\$569**

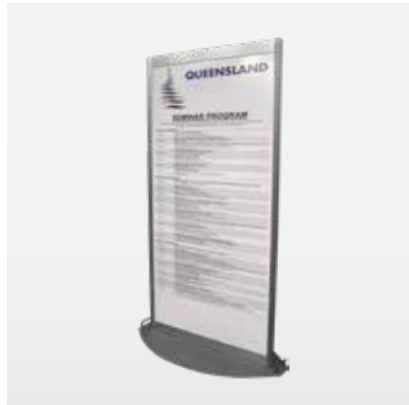

OCTA FLAT

Sign Frame

- Single or Double Sided
- 2m Panel Size: 965(w) x 2000mm(h)
- 2.5m Panel Size: 965(w) x 2320mm(h)

2m Frame Only **062801** **\$144**
2m Single Print **078401** **\$368**
2.5m Frame Only **062802** **\$157**
2.5m Single Print **078402** **\$426**



OCTA CURVED

Sign Frame

- Single or Double Sided
- 2m Panel Size: 1078(w) x 1880mm(h)
- 2.5m Panel Size: 1078(w) x 2320mm(h)

2m Frame Only **062901** **\$144**
2m Single Print **078501** **\$386**
2.5m Frame Only **062902** **\$157**
2.5m Single Print **078502** **\$477**



SMALL CHROME

Sign Holder

- Insert size: 290(w) x 420mm(h)
- Overall height: 1490mm

Frame Only **060916** **\$88**
Single Print **078601** **\$24**

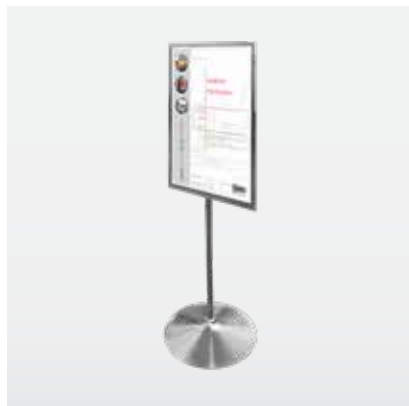

A2 CHROME

Sign Holder

- Insert size: 420(w) x 594mm(h)
- Overall height: 1560mm

Frame Only **060917** **\$96**
Single Print **078602** **\$47**



LARGE CHROME

Sign Holder

- Insert size: 500(w) x 750mm(h)
- Overall height: 1560mm

Frame Only **061016** **\$104**
Single Print **078701** **\$71**

FAUX POTTED PLANTS & FOLIAGE



BAMBOO PLANT

Pot Plant

Large (1700mm) **068503** \$103
 Medium (630mm) **068507** \$81



VARIEGATED FICUS

Pot Plant

Large (1700mm) **067346** \$103
 Medium (900mm) **068501** \$92

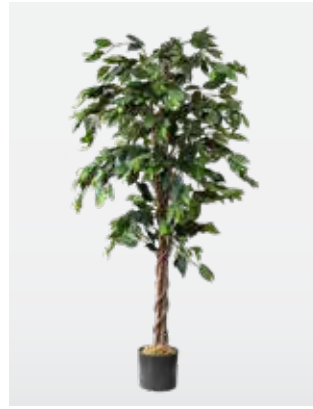

DARK LEAF FICUS \$103

Pot Plant

- 1700mm high

Item Code **068509**

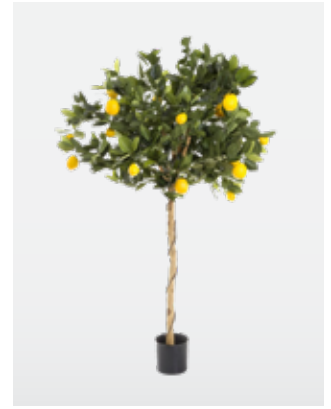

LEMON TREE \$103

Pot Plant

- 1200mm high

Item Code **068510**



MONSTERA

\$92

Pot Plant

- 900mm high

Item Code **068514**

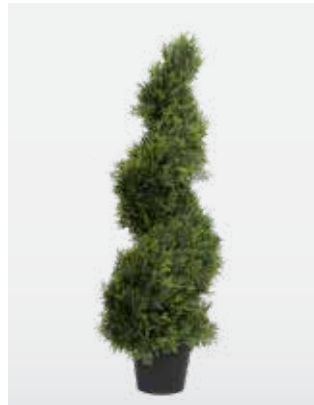

SPIRAL HEDGE

\$163

Pot Plant

- 1800mm high

Item Code **068506**



LOOSE IVY

\$21

Foliage

- Per linear meter

Item Code **068511**

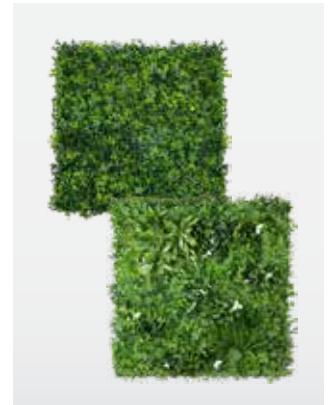

GREEN WALL

Foliage

- Per square meter

Spring Sensation **068512** \$195_{p/m²}
 White Oasis **068513** \$195_{p/m²}



FERNS & PALMS

Foliage

1) Boston Fern (650mm high)	068504	\$81	4) Ruffle Fern (450mm)	066613	\$81
2) Leather Fern (470mm high)	066609	\$81	5) Cycad Palm (450mm high)	066607	\$81
3) Margaritum Fern (600mm high)	066611	\$81			

DEFINITIONS & STANDARD CONDITIONS OF HIRE

- 1. DEFINITIONS** "Exhibit" means Exhibit Systems Pty Ltd ABN 78 091 935 116;
"Customer" means the person or entity identified as such in the relevant Hire Agreement;
"Hire Agreement" means the approved quote/order/invoice for the hire of the Goods.
- 2. CANCELLATIONS** If a Customer cancels an order or hire after the Goods have been delivered or installed by Exhibit, the Customer is liable for and must still pay the full charges under the Hire Agreement to Exhibit.
If a Customer cancels an order or hire less than five (5) days before the Goods have been delivered or installed by Exhibit, the Customer is liable for and must still pay 50% of the charges under the Hire Agreement. If a Customer cancels an order or hire less than fourteen (14) days before the Goods have been delivered or installed by Exhibit, the Customer is liable for and must still pay 25% of the charges under the Hire Agreement.
Regardless of when cancellation occurs, for any design time and production elements, including graphics, that are already produced or in production, full payment is required. This includes any materials sourced for production.
- 3. CARTAGE, DAMAGE WAIVER, LATE ORDERS & ONSITE ORDERS** In addition to the hire charges, the Customer must pay:
(a) cartage fees at a rate of 27% of the hire charges;
(b) damage waiver fees at a rate of 8% of the hire charges;
(c) electrical delivery & installation fee at a rate of 35% of electrical charges;
(d) if payment is made by credit card, a credit card surcharge of 1.8% +GST;
(e) where the order is placed after an exhibition deadline date or after the commencement of installation, a late order surcharge of 25% of the hire charges.
- 4. PRICES & CHARGES** Subject to change without notice but will not be changed after receipt of order & confirmation payment. All quoted rates are for the duration of the event (maximum 7 days). All hire items are excluding GST and will attract 10% tax.
- 5. DELIVERY & PICKUP** All goods will be delivered the day or morning prior to opening and must be available for collection immediately following closure of the event. It is the Customer's responsibility to ensure it does not leave any of its property or chattels in or on the Goods immediately prior to the return or collection of the Goods & Exhibit will not be liable to the Customer for any loss.
- 6. TERMS OF PAYMENT** Payment terms are strictly seven days from receipt of invoice or immediate payment if event is within seven days of order
- 7. DISPARITY IN ORDER** Please notify our staff onsite of any disparity to your order. No claims will be recognised after the event.

GENERAL TERMS AND CONDITIONS - HIRE AGREEMENT



- The Goods are hired to the Customer by Exhibit for the Hire Period on the terms of the Hire Agreement.
- The Customer acknowledges that Exhibit retains title and ownership of the Goods (despite any insolvency of the Customer) and the Customer and Exhibit expressly agree that the Goods will not, and it is not intended that Goods will become a fixture. The right of the Customer to use the Goods is as bailee only on the terms of the relevant Hire Agreement.
- The Customer must pay Exhibit the hire charges at the rates set out in the Hire Agreement and any additional charges as specified under the Hire Agreement. The Customer is not entitled to any discount or rebate if the Goods are not used by the Customer for any part of the Hire Period.
- The Customer will be liable for stamp/hire duty, GST and all other applicable taxes, duties, levies, penalties, and any other government charges imposed under the Hire Agreement.
- Unless Exhibit has otherwise agreed in writing, the Customer must pay all fees, charges, and costs under the Hire Agreement before any of the Goods are delivered or installed by Exhibit.**
- If the Customer requires Exhibit to deliver, collect or install the Goods, the Customer will be liable for the cost of delivery, collection, or installation. Exhibit will not be responsible for any delays in delivery or installation or failure to deliver due to causes beyond its control including but not limited to acts of God, war, terrorism, mobilisation, civil commotion, riots, embargoes, orders or regulations or governments of any relevant jurisdiction, fires, floods, strikes, lockouts or other labour difficulties, shortages of or inability to obtain shipping space or land transportation.
- The Customer must notify Exhibit of any problems with the Goods upon delivery or installation, failing which the Customer may not make any claim in respect of the Goods or under the Hire Agreement.
- The Customer consents to Exhibit inspecting the Goods from time to time whilst the Goods are in the Customer's possession or control. For this purpose, the Customer and Exhibit agree that during the period of any inspection by Exhibit, Exhibit will have exclusive possession and control of the Goods to the exclusion of any other person and may alter, test, repair or replace all or any of the Goods with other Goods.
- Obligations of the Customer: In the event that the Goods become unsafe to use, break down or fail the Customer will:
 - Immediately stop using the Goods and notify Exhibit;
 - Take all steps necessary to prevent injury occurring to persons or property as a result of the condition of the Goods;
 - Take all steps necessary to prevent any further damage to the Goods, and
 - Not repair or attempt to repair the Goods without Exhibit's written consent.
- Exhibit may terminate the Hire Agreement immediately by notice to the Customer, if:
 - a Default occurs;
 - The Customer breaches any term of the Hire Agreement
 - The Customer takes any action, permits, or causes any action to be taken which prejudices Exhibit's rights in the Goods; or
 - In the absolute opinion of Exhibit, the Customer becomes unable to pay the Customer's debts as and when they become due, is insolvent or otherwise ceases to carry on business or otherwise ceases to carry on business.
- The Customer is responsible for the Goods and associated accessories whilst in the Customer's possession or control. If the Goods are lost, stolen or deliberately damaged whilst in the Customer's possession or control, the Customer will be liable for and immediately pay on demand:
 - Any costs incurred by Exhibit in repairing or replacing the Goods, and
 - Any other costs incurred by Exhibit as a result of the loss, theft or damage of the Goods, including applicable hire charges when the damage was caused by the negligence or act or omission of the Customer
- If the Customer is in breach of the Hire Agreement or if Exhibit has terminated the Hire Agreement, Exhibit may take any step, including legal action, to recover the Goods, including by entering the Customer's premises or such premises where the Goods are located, and the Customer irrevocably authorises Exhibit and its agents to do so. The Customer indemnifies Exhibit in respect of any claims, damages or expenses arising out of any action taken under this clause.





SYDNEY

-  +61 2 9982 5511
-  PO Box 801, Freshwater NSW 2096
-  5 Boola Place, Cromer NSW 2099
-  sales@exhibitsystems.com.au
-  www.exhibitsystems.com.au

BRISBANE / GOLD COAST

-  +61 7 3805 1543
-  25 High Road, Bethania Qld 4205

MELBOURNE

-  +61 3 8375 1638
-  37 Sunline Drive, Truganina VIC 3029

24

YEARS
working
on your side